

Zeramex XT

User guide



Zeramex XT

XT

Dear user,
Welcome to Zeramex.

The Zeramex XT implant system is an innovation in the family of two-piece, reversible screw-in and 100% metal-free ceramic implants.

The root-shaped design of the Zeramex XT implants achieves high primary stability and offers high prosthetic flexibility thanks to its unique internal connection.

The uncomplicated portfolio offers all the options to choose from. Find out all about the Zeramex implant systems today. Improve the experience of your customers and make your own job easier.

Our experts will be glad to help you if you have any questions.

Distributor USA

Emerginova LLC
2730 SW 3rd Avenue Suite 202-1
Miami, Florida 33129, USA
T 001 786 622 2016
sales@zeramexusa.com
www.emerginova.com/zeramex



Contents

Information

- 4 System overview
- 8 Case planning in 5 steps
- 10 Surgical tools
- 12 Technical information

Surgical phase

- 16 Planning the insertion depth
- 18 Drilling protocols
- 23 Handling

Prosthetic restoration

- 26 Soft tissue management
- 26 Temporary restoration
- 28 Conventional impression taking
- 29 Prosthetic process
- 30 Prosthetic tools
- 31 Screwed connection
- 35 Cemented connection
- 36 Platform switching
- 37 Zeramex Docklocs® abutments
- 39 Technical data for abutments
- 40 Grinding standard abutments
- 41 Zeramex XT screws

Range

- 44 Range

Note

- 56 General Information
- 57 Contact

Caution!

The Zeramex XT system is not compatible with previous Zeramex T generations. If you have any questions or concerns, please don't hesitate to contact us:
Tel. 001 786 622 2016

System overview

The system for all common indications, particularly well suited for front tooth restorations.

Biocompatible tools

Zeradrill

The biocompatible reusable drill with carbon coating (DLC)

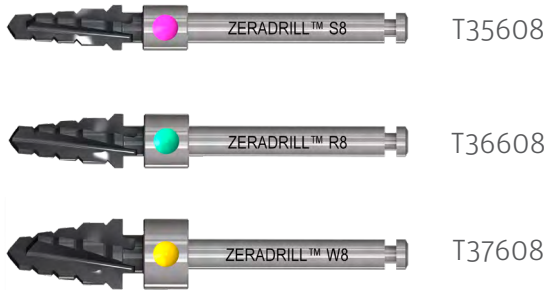

Zeratap

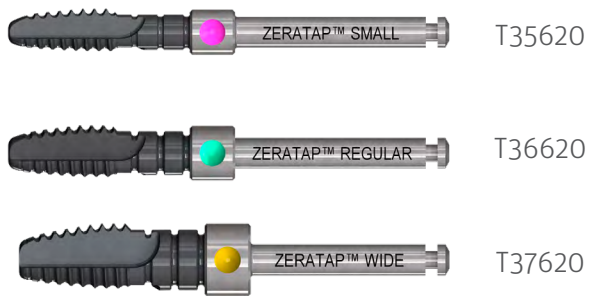

Surgical Kit



Prosthetic Kit

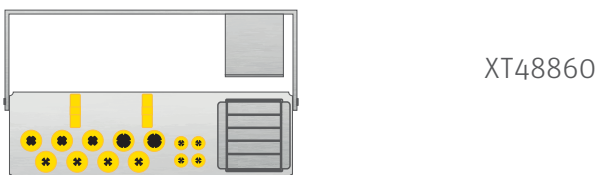

Colour coding and sizes

Example of implant

Regular $\varnothing 4.2 \times 14$ mm



\varnothing Platform	3.85 mm	4.2 mm	5.5 mm
\varnothing Endosseous	3.5 mm	4.2 mm	5.5 mm
Collar height	1.6 mm	1.6 mm	1.6 mm
Optional	0.6 mm	0.6 mm	0.6 mm

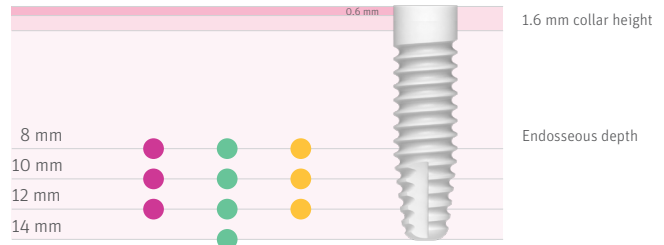

SB = Small Base
 RB = Regular Base
 WB = Wide Base

Imaging and Connection Tools

Surgery

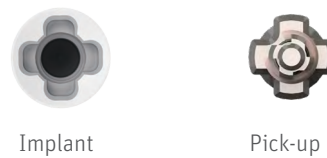









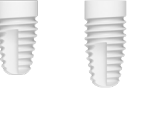

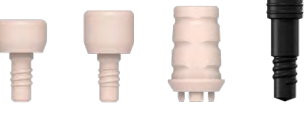
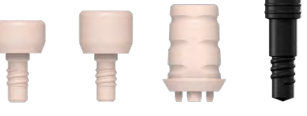
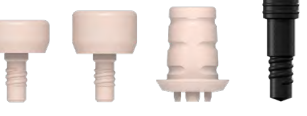

Prosthetic

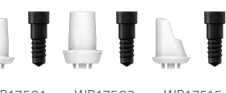

System overview



Implants (∅ endosseous) Material: ZrO ₂ ATZ	Zeramex XT ∅3.5 mm SB	Zeramex XT ∅4.2 mm RB	Zeramex XT ∅5.5 mm WB
	 XT15508 XT15510 XT15512	 XT16508 XT16510 XT16512 XT16514	 XT17508 XT17510 XT17512
Prosthetic platform	SB ∅3.85 mm	RB ∅4.2 mm	WB ∅5.5 mm
Healing caps Material: PEEK	 SB35500	 RB36500	 WB37500
Soft Tissue Management Gingiva former, provisional abutments Material: PEEK, Vicarbo	 SB35503 SB35504 SB35530	 RB36503 RB36504 RB36530	 WB37503 WB37504 WB37530
Taking an impression open/closed Material: PEEK-CW30, Aluminium	 SB35510 SB35512 SB35513	 RB36510 RB36512 RB36513	 WB37510 WB37512 WB37513
Standard Abutments including screw Material: ZrO ₂ ATZ, Vicarbo	 SB15501 SB15502 SB15515	 RB16501 RB16502 RB16515	 WB17501 WB17502 WB17515
Docklocs® Abutments (Locator® dental prosthesis) Material: ZrO ₂ ATZ Suitable for all platforms SB/RB/WB	 SB15542 SB15543 SB15544		
Laboratory auxiliary parts Material: Aluminium, PEEK green, PEEK-CW30	 SB35522 RB36554 RB36521	 RB36522 RB36554 RB36521	 WB37522 RB36554 RB36521
Screw Material: Vicarbo	 RB16550		

Information: Further details for orders from page 44.

Docklocs® is a registered trademark of MEDEALIS GmbH and our alternative to the LOCATOR® technique.
 Locator® is a registered trademark of Zest Anchors, Inc., USA.

The Zeramex XT implant



The new generation of ceramic implants

The Zeramex XT implant: an innovation in the family of two-piece, reversible screw-in Zeramex ceramic implants. The root-shaped design of the Zeramex XT implant achieves high primary stability. The new internal connection ensures high prosthetic flexibility.



Hot isostatic post-compacted (HIP) zirconium dioxide ATZ

The Zeramex XT implant is manufactured from hard and hot isostatic post-compacted (HIP) zirconium dioxide ATZ blanks. No thermal process (sintering) or finishing takes place after the final shaping of the outer and inner geometry of the implant. This ensures a high degree of precision and further changes in the material structure are prevented. This manufacturing process is very complex and requires a great deal of experience and know-how.



“Bolt-in-Tube” – the simple and strong ceramic connection

The “Bolt-in-Tube” connection for Zeramex XT implants provides certainty when taking impressions and for temporary and permanent prosthetic restorations. The design elements of this connection have been selected to provide very high stability, while taking into account the typical material properties of ceramics.

The special geometry with the four interlocks and high precision enables fast and easy insertion and alignment of the abutment.

The core of the connection is the Vicarbo screw. It acts as a bolt, which anchors the abutment in the implant. The extremely hard ceramic is combined with a very stiff, carbon fibre-reinforced high-performance polymer. Similar to reinforced concrete, the ceramic absorbs the compressive forces, while the Vicarbo screw counteracts tensile forces.

Root-shaped with internal connection

Prosthetic flexibility

The Zeramex XT implant system offers a high degree of prosthetic flexibility thanks to straight, angled and fully customizable abutments.

“Bolt-in-tube”

The “Bolt-in-Tube” connection prevents traction from being exerted on the ceramic. Forces are absorbed by the Vicarbo screw which functions as a bolt.

Internal connection

The four cross-shaped retaining elements provide the ideal torque on insertion so that the implant can be screwed in without stress peaks being exerted on the bone.

The **slightly bevelled contact surface** of the implant was developed to facilitate centring and placement of the abutment and auxiliary parts.

Zerofil surface

Excellent osseointegration with the hydrophilic, sandblasted and etched Zerofil surface. Surface treatment up to collar height of 0.6 mm.



500µm

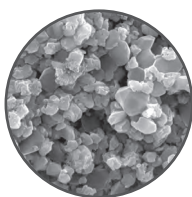

2µm

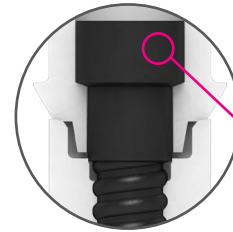
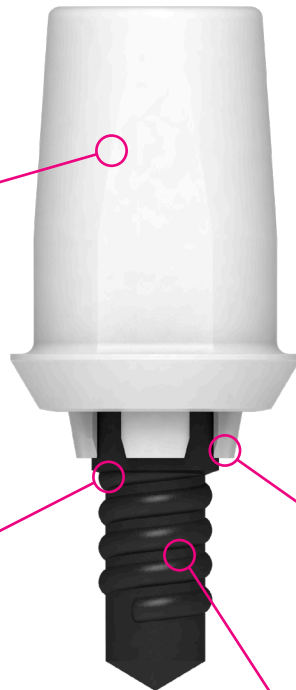

Screw head \varnothing 2.8 mm

Four interlocks

The four interlocks provide precise anti-rotation protection. The “Bolt-in Tube” connection prevents force from being transmitted via the interlocks. These four retaining elements help the abutment to be securely and quickly placed in the implant.

Vicarbo screw

The Vicarbo screw is a precision screw to optimally capture occlusal forces. When tightened, it grips the existing contour of the thread thanks to the significantly different hardnesses of the ceramic and screw.

Variable placement depth

The Zeramex XT implant is placed 1.6 mm supracrestal (optional 0.6mm) and offers high prosthetic flexibility.

High primary stability

The thread design and cylindrical-conical implant shape achieve high primary stability.

Reservoir for bone grafts

The reservoir for bone grafts at the implant tip simplifies the placement of the implant.

Zirconia dioxide ATZ-HIP material

Innovative material for high stress and biocompatibility.

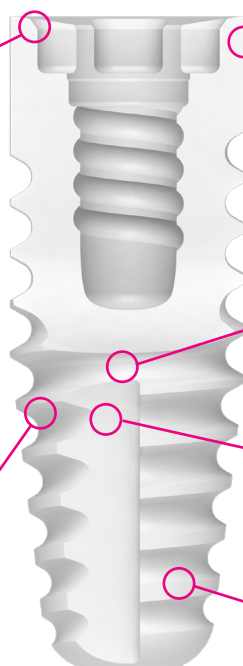
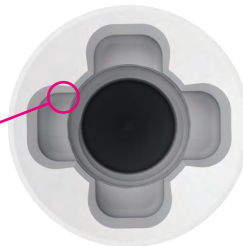

Case planning in 5 steps

1. Preparation phase

As with any surgical procedure, implantation also requires proper professional preparation. Preparation includes a thorough dental and general health examination which includes taking X-ray images and a detailed discussion with the patient regarding their prior medical history. Conventional, prosthetic and periodontal preparatory treatment should be completed before initiating the implant therapy. The options and intentions for later prosthetic restoration (item 5) should be included in the discussion from the start. Use this baseline to work out the individual therapy plan and create a protocol. CT and DVT can be used to gather information about bone conditions which are difficult to diagnose. The bone and its quality decide ultimately on the position and number of implants.

2. Implant selection

Implant length and diameter are based on X-ray images. Always use the implant with the largest possible diameter. The vestibular wall thickness must be at least 1 mm, however, to preserve adequate blood circulation. If this is not possible, bone grafting will be necessary.

3. Bone preparation

It is essential to follow the drilling protocol starting on page 18. You must provide constant cooling during drilling because temperatures higher than 42 °C may alter bone structure and affect osseointegration!

Important!

Insert the drill only to the specified marking. The implant is not self-tapping; always use a thread cutter. If the cortical bone is very hard, use the Zeradrill extension. Follow the corresponding drilling protocols. Replace drills after about 20 implantations or in case of reduced cutting performance.

4. Implant insertion

We recommend tightening the implant by hand and not tightening at more than 15 rpm. The implant is placed 1.6mm supracrestal, but can optionally be sunk deeper (0.6mm supracrestal). The edge of the implant must be easily accessible in order to correctly tighten the abutment after the initial healing phase. Very good primary stability is important. Use a healing cap to cover the implant after the placement and close the gums. A gingiva former can be used directly in exceptional cases. The minimum required healing period is 3 months for the lower jaw and 6 months for the upper jaw.

Comply with protocol torque

We recommend a screw-in torque of 20–30 Ncm. The maximum torque for ø3.5 mm SB implants is 35 Ncm. For ø4.2 mm RB and ø5.5 mm WB implants, the maximum torque is 45 Ncm. Never exceed this torque. The required torque is always less than the maximum torque, depending on the bone quality (soft bone → less torque) and implant length (short implants → less torque).

5. Prosthetic restoration

A range of standard and Zeramax Docklocs® abutments for removable prostheses is available for prosthetic restorations. Find out more on page 26 onwards. Prosthetic restoration.

Distances at bone level

Distance to adjacent tooth at bone level

A minimum distance of **1.5 mm** between the implant shoulder and the adjacent tooth is required at bone level (mesial and distal).

Distance to adjacent implant at bone level

A minimum distance of **3 mm** between two adjacent implant shoulders (SB/RB/WB) (mesiodistal) is required.

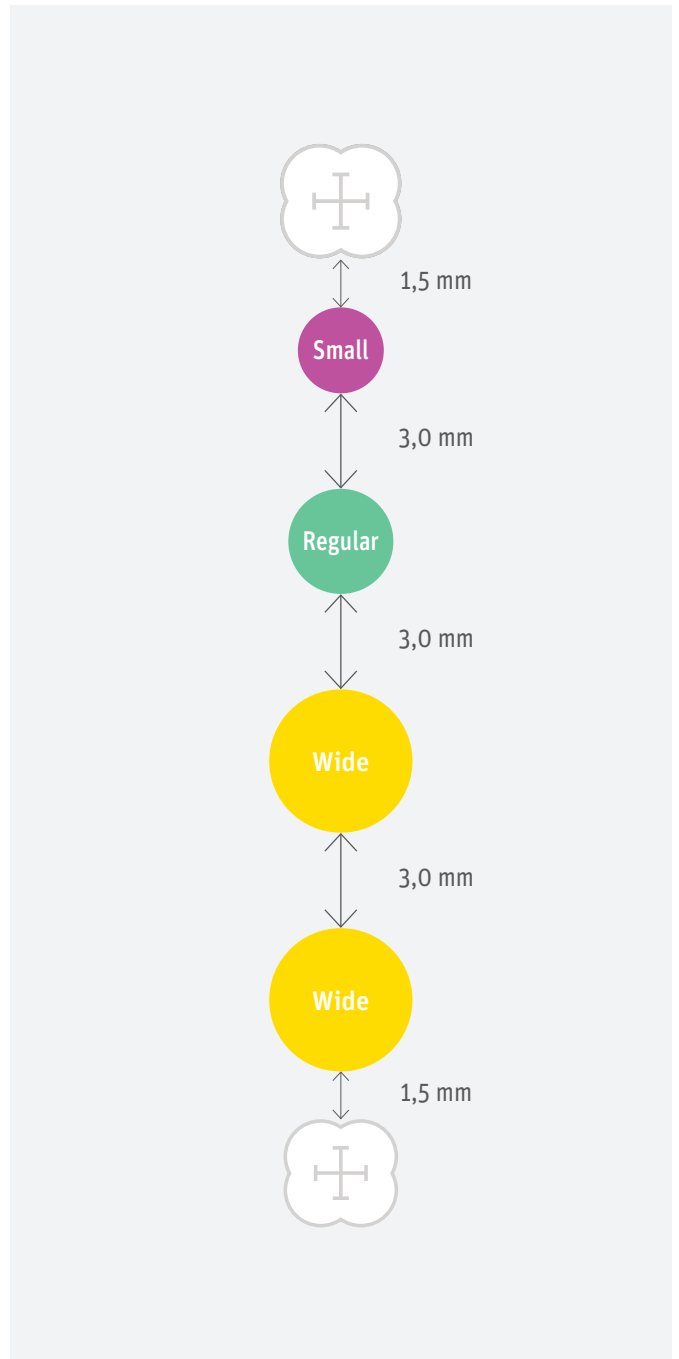

Surgical tools

XT

Important!

Follow the corresponding drilling protocols. Replace drills after about 20 implantations or in case of reduced cutting performance.

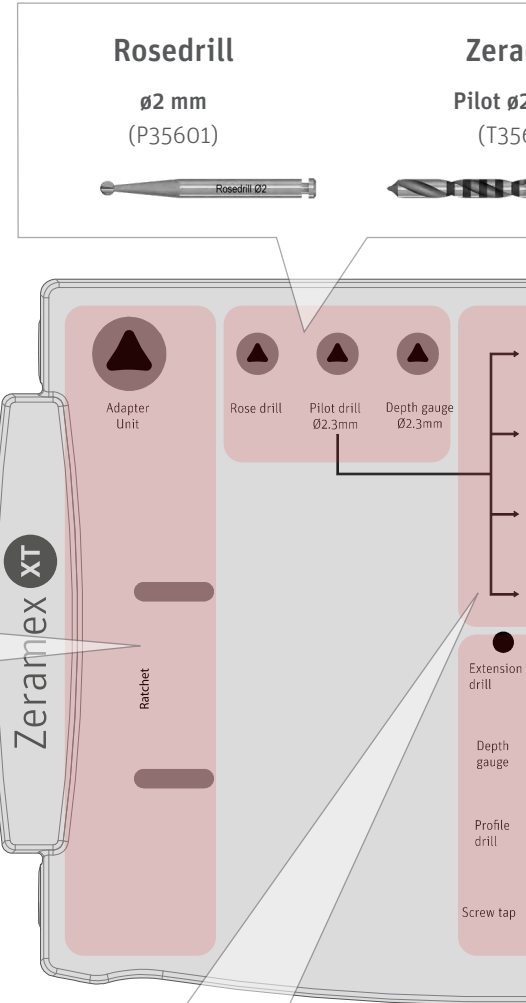

Ratchet

Ratchet Adapter Unit Short
(P48932)

Surgical Ratchet
(P48935)

Zeradriill		
<p>S8 (8 mm) (T35608)</p>	<p>R8 (8 mm) (T36608)</p>	<p>W8 (8 mm) (T37608)</p>
<p>S10 (10 mm) (T35610)</p>	<p>R10 (10 mm) (T36610)</p>	<p>W10 (10 mm) (T37610)</p>
<p>S12 (12 mm) (T35612)</p>	<p>R12 (12 mm) (T36612)</p>	<p>W12 (12 mm) (T37612)</p>
<p>S14 (14 mm) (T35614)</p>	<p>R14 (14 mm) (T36614)</p>	

Zeradrill
Pilot $\varnothing 2.3$ mm
(T35602)

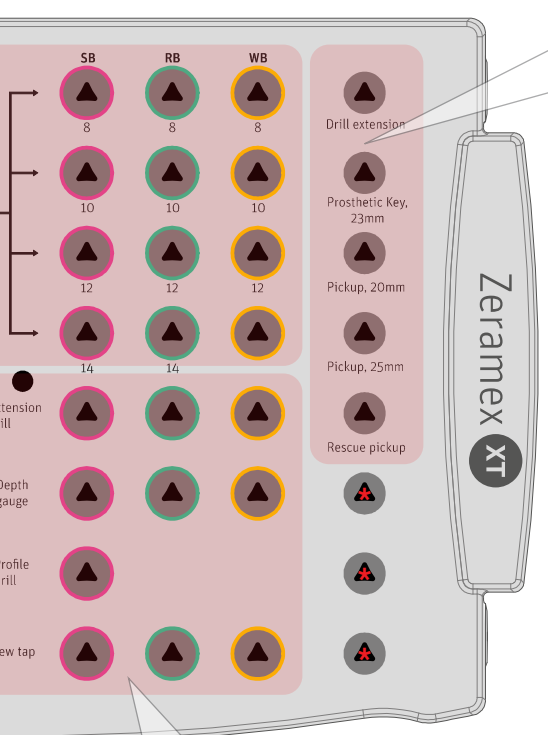

Depth gauge
Depth gauge $\varnothing 2.3$ mm
(T38650)

Zeramex XT

SB RB WB

8 8 8

10 10 10

12 12 12

14 14

Drill extension

Prosthetic Key, 23mm

Pickup, 20mm

Pickup, 25mm

Rescue pickup

Depth gauge

Profile Drill

New tap

Extension
Drill Extension
(C7650)



Pick-up
Pick-up (20 mm)
(XT36620)



Pick-up (25 mm)
(XT36625)

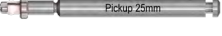

Rescue Pick-up
(XT36622)



Prosthetic key
Prosthetic key (19 mm)
(XT38619)



Prosthetic key (23 mm)
(XT38623)



Prosthetic key (28 mm)
(XT38628)



* These slots are reserved for system expansion.

Zeradrill Extension

Small $\varnothing 3.5$ mm
(T35622)



Regular $\varnothing 4.2$ mm
(T36622)

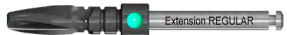

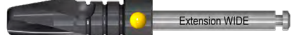

Wide $\varnothing 5.5$ mm
(T37622)



Profile Drill SB
Small $\varnothing 3.5$ mm
(XT35630)



Depth gauges
Small/Regular/Wide
(T38650)

Zeratap
Small $\varnothing 3.5$ mm
(T35620)



Regular $\varnothing 4.2$ mm
(T36620)



Wide $\varnothing 5.5$ mm
(T37620)



Technical Information

Zeramex Implants

Labelling and colour coding

The implants are colour-coded on the packaging.

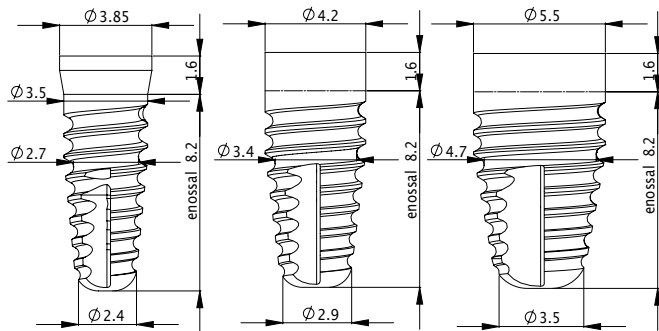

Example of 8 mm implants SB/RB/WB

Description

The Zeramex XT Implant is an innovation in the family of two-piece, reversible screw-in Zeramex ceramic implants. The root-shaped design of the Zeramex XT implant achieves high primary stability. The internal connection ensures high prosthetic flexibility.

Indication

Information on indications is available in the instructions for use (IFU) at www.zeramex.com.

Material

Zirconium dioxide ATZ, ZrO₂-ATZ-HIP white

Order information

SB ø3.5 mm

- XT15508 Zeramex XT ø3.5 mm SB, 8 mm (9.8 mm)
- XT15510 Zeramex XT ø3.5 mm SB, 10 mm (11.6 mm)
- XT15512 Zeramex XT ø3.5 mm SB, 12 mm (13.6 mm)

RB ø4.2 mm

- XT16508 Zeramex XT ø4.2mm RB, 8 mm (9.8 mm)
- XT16510 Zeramex XT ø4.2 mm RB, 10 mm (11.6 mm)
- XT16512 Zeramex XT ø4.2 mm RB, 12 mm (13.6 mm)
- XT16514 Zeramex XT ø4.2 mm RB, 14 mm (15.4 mm)

WB ø5.5 mm

- XT17508 Zeramex XT ø5.5 mm WB, 8 mm (9.8 mm)
- XT17510 Zeramex XT ø5.5 mm WB, 10 mm (11.6 mm)
- XT17512 Zeramex XT ø5.5 mm WB, 12 mm (13.6 mm)

Technical information

Zerafil surface

Labelling

Zerafil is available for all Zeramex implants and not specifically labelled.

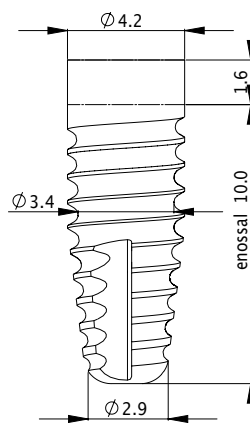

Bsp. 10 mm Implantat RB

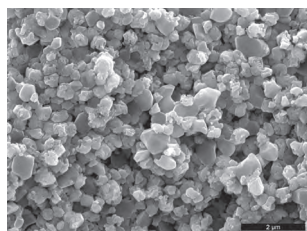
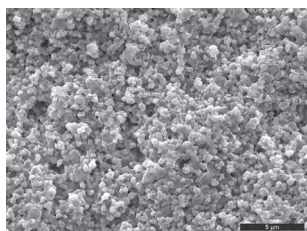
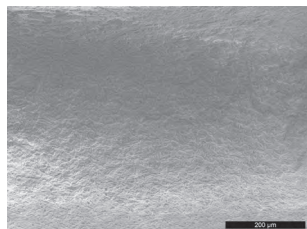
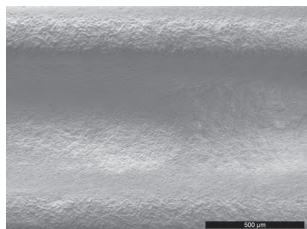

Description

The Zerafil surface is a micro-structured implant surface that enables optimum, quick and safe osseointegration of the implants.

Blasting with high-grade corundum lends the surface its macrostructure; subsequent acid etching lends it its microstructure, which is key to osseointegration.

Acid etching guarantees a pure implant surface and ensures the required hydrophilic properties.

Design

The endosseous section of the implant features the Zerafil surface. The neck section (0.6 mm) is polished smooth and not structured with Zerafil.

Osseointegration

The success rate of Zeramex XT implants with a Zerafil surface is 98 %¹⁾, and bears witness to the decisive osseointegration thanks to the optimum surface structure.²⁾ The hydrophilic implant surface Zerafil is sandblasted and etched so that osteoblasts grow directly up to the implant and firm adhesion to the implant surface is achieved.³⁾

1) Status January 2020, internal data from market surveillance

2) Chappuis V, Cavusoglu Y, Gruber R, Kuchler U, Buser D, Bosshardt DD./Osseointegration of Zirconia in the Presence of Multinucleated Giant Cells. 2016

3) Jank S, Hochgatterer G./Success Rate of Two-Piece Zirconia Implants: A Retrospective Statistical Analysis. 2016

Technical Information

Zeradrill drill

Labelling and colour coding

The size of the drill is marked on the packaging and the shaft, and appropriate colour coding is applied.

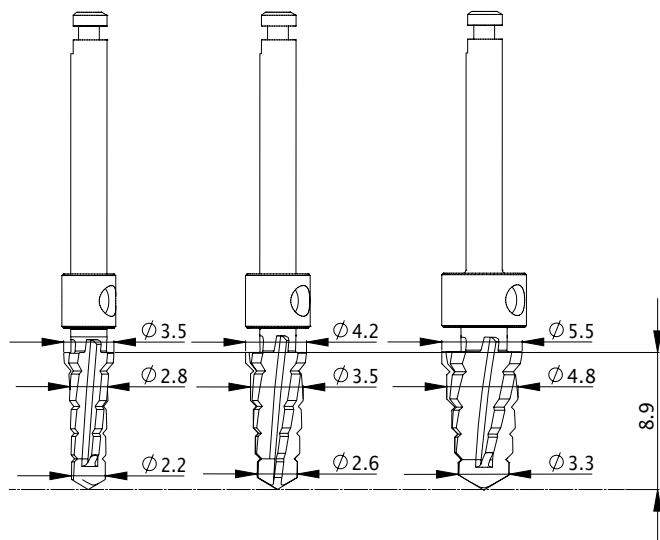

Example of 8 mm drill

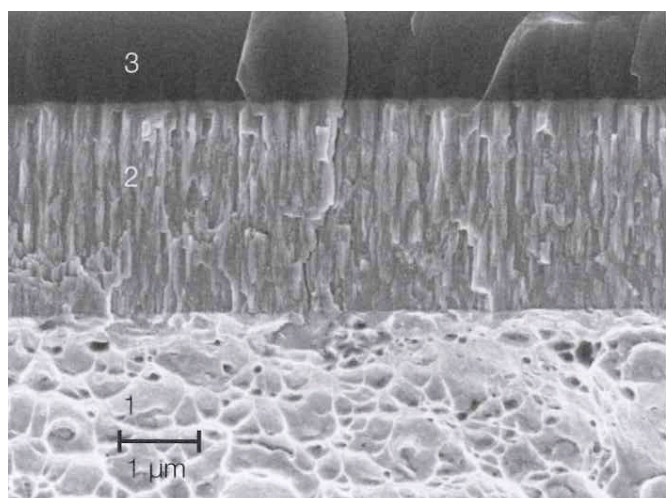

Description

The Zeradrill drill guarantees very good bone preparation for the implant with maximum protection of the surrounding tissue and cells.

The use of hardened medical-grade stainless steel as the base material allows the heat generated by drilling to be efficiently conducted away.

Zeradrill drills are furnished with a pure, metal-free and amorphous carbon coating. This only contains carbon and hydrogen and is therefore 100% metal-free and biocompatible.

Material

1. Medical-grade stainless steel
2. Protective layer
3. DLC carbon coating* (a-C:H)

*DLC (Diamond-like Carbon) High-performance coating made of diamond-like carbon

Zeramex XT

Surgical phase



Surgical phase

Planning the insertion depth with the drill stop

Drill stop

The drill stop allows the drilling depth to be precisely controlled. The drill stop is placed on the drill sleeve. It allows you to insert the implant 1.6mm or 0.6mm supracrestal.

Note: Correct position for insertion depth:

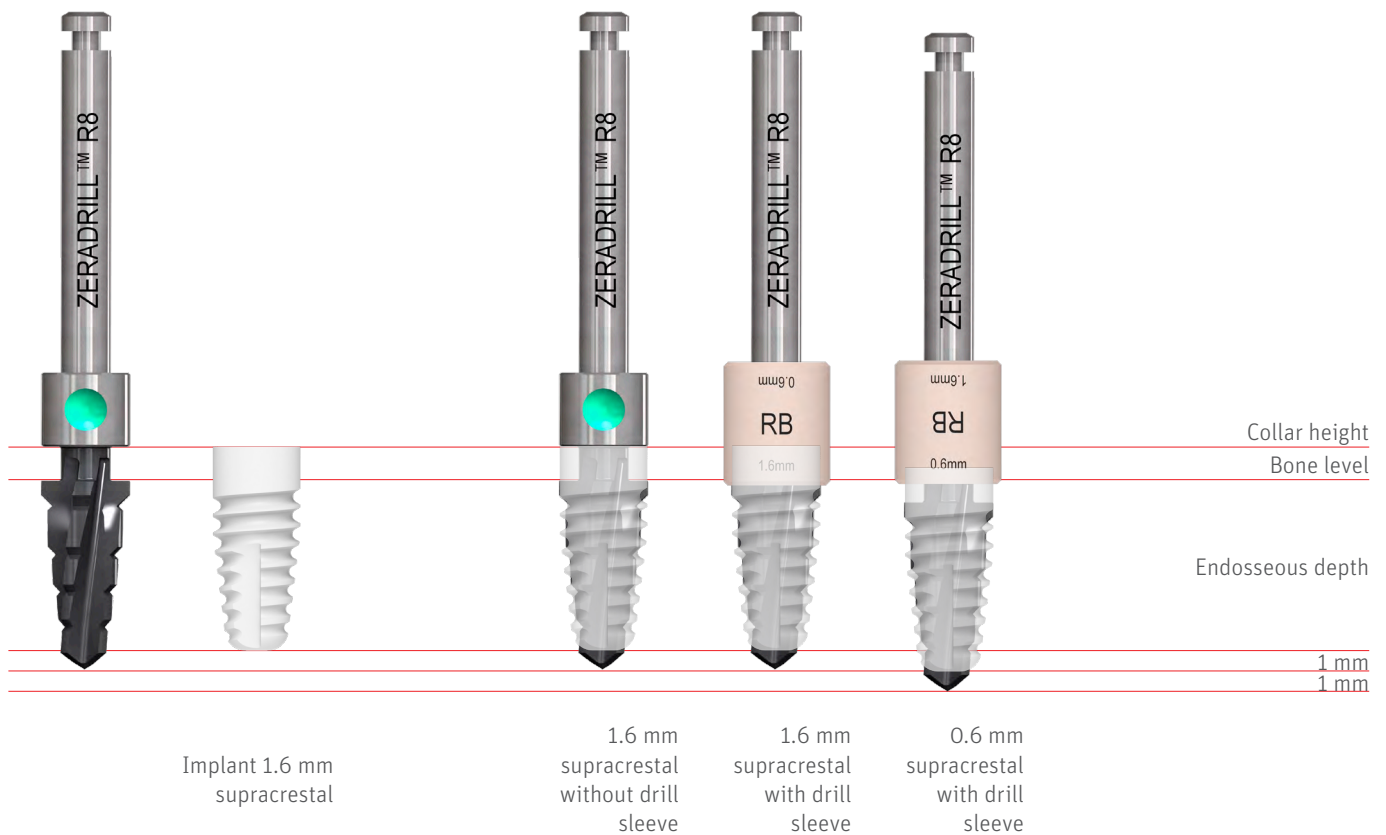
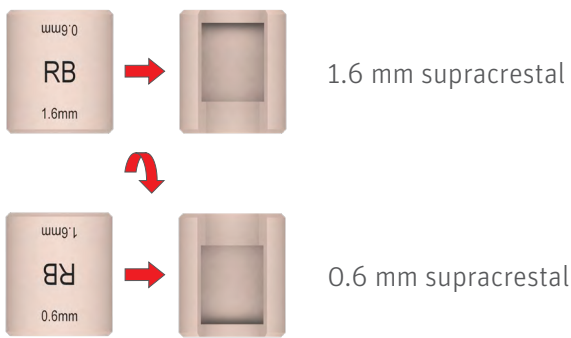

Surgical phase

Depth marks

Diameter

The diameter is indicated on each tool by a colour code.



Example of implant

Regular $\varnothing 4.2 \times 8$ mm
1.6 mm supracrestal

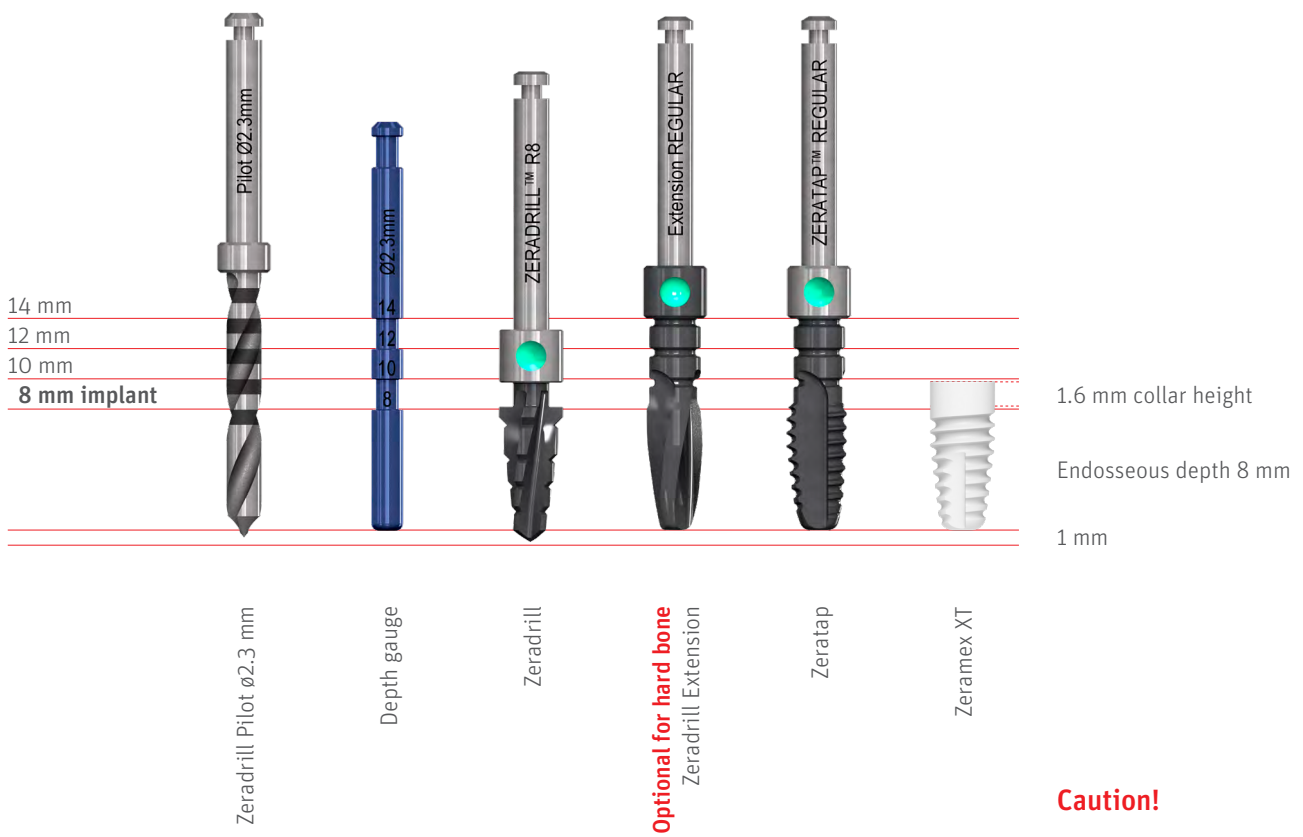

Caution!

The drilling depth is up to 1mm deeper than the corresponding implant.

Sterilization before surgery

Surgical preparation includes steam sterilization of the surgical tray (surgical instruments) at 132 °C / 270 °F or 134 °C / 274 °F / for: 18 minutes

Important!

If the drills and instruments are used more than once, place them in the saline solution during the treatment.

Surgical phase

Planning drilling for 0.6 mm supracrestal

Optional insertion depth up to **0.6 mm** supracrestal

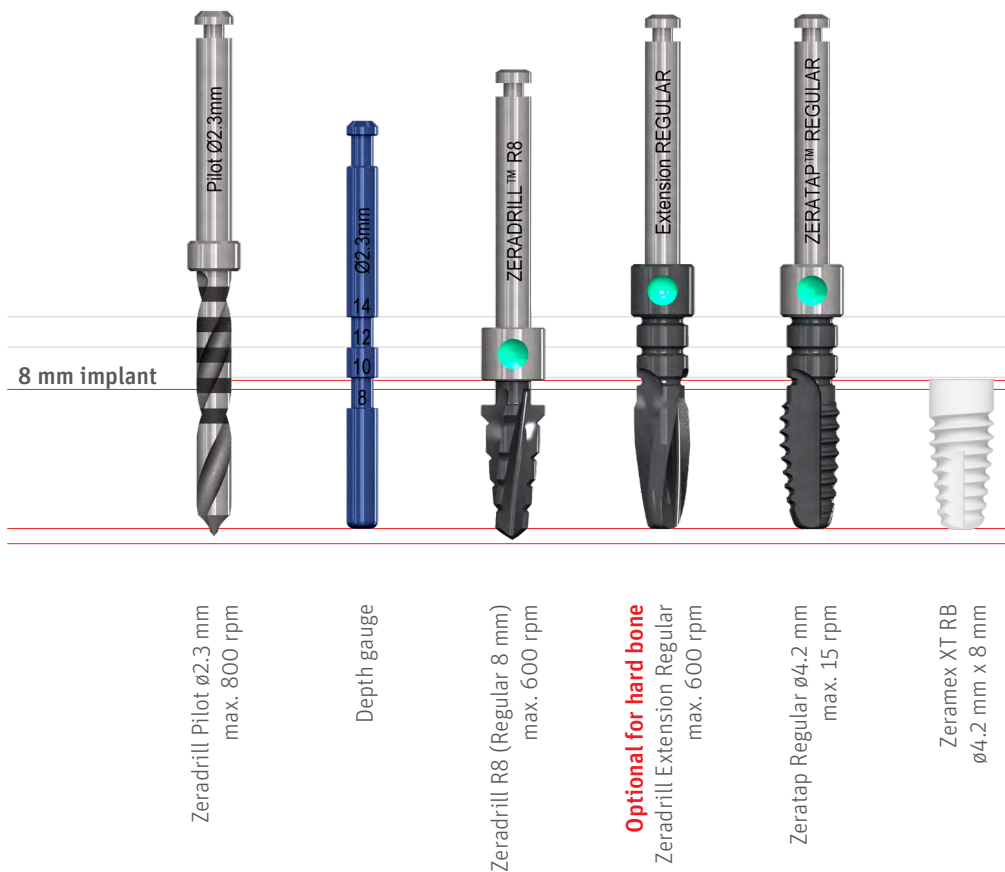

Article number	Selected implant length	Pilot Drill drill hole depth	Zeradrill	Extension	Zeratap	Screw-in depth	Effective hole depth
XT15508 XT16508 XT17508	8 mm	9 mm	Up to sleeve	9 mm	9 mm	0.6 mm Supracrestal	10 mm
XT15510 XT16510 XT17510	10 mm	11 mm	Up to sleeve	11 mm	11 mm	0.6 mm Supracrestal	12 mm
XT15512 XT16512 XT17512	12 mm	13 mm	Up to sleeve	13 mm	13 mm	0.6 mm Supracrestal	14 mm
XT16514	14 mm	*	*	*	*	*	*

*** For a length of 14 mm, we recommend that the implant is not placed 0.6 mm supracrestal.**

Surgical phase



Drill protocol $\varnothing 3.5$ mm SB (1.6 mm supracrestal)



Rosedrill $\varnothing 2.3$ mm
max. 800 rpm

Zeradrill Pilot $\varnothing 2.3$ mm
max. 800 rpm

Zeradrill S8 (Small 8 mm)
max. 700 rpm

Optional for hard bone
Zeradrill Extension Small
max. 700 rpm

Zeratap Small $\varnothing 3.5$ mm
max. 15 rpm

Zeramax XT SB
 $\varnothing 3.5$ mm x 8 mm

Attention! Indications:

- Lateral incisors in the upper jaw
- Anterior teeth in the lower jaw
- Completely for Docklocs dentures for 4 implants in the lower jaw and 6 implants in the upper jaw

Example of implant

Small $\varnothing 3.5 \times 8$ mm



14 mm

12 mm

10 mm

1.6 mm collar height

Endosseous depth 8 mm

1 mm

Note: Optionally, the implant can also be positioned 0.6 mm supracrestal (instead of 1.6 mm). The drill and thread cutter must be drilled 1 mm deeper in this case.

Endosseous $\varnothing 3.5$ mm

Important!

With $\varnothing 3.5$ mm implants, do not exceed a torque of 35 Ncm.

Caution!

Use the tap according to the bone quality.

*Our alternative to the LOCATOR® technique

Surgical phase

Drill protocol 3.5 mm SB (0.6 mm supracrestal)



Rosedrill Ø2,3 mm
max. 800 rpm

Zeradrill Pilot Ø2.3 mm
max. 800 rpm

Zeradrill S8 (Small 8 mm)
max. 700 rpm

Optional for hard bone
Zeradrill Extension Regular
max. 700 rpm

Zeramex Profile Drill SB
max. 350 rpm

Zeratap Small Ø3.5 mm
max. 15 rpm

Zeramex XT SB
Ø4.2 mm x 8 mm

Attention! Indications:

- Lateral incisors in the upper jaw
- Anterior teeth in the lower jaw
- Completely for Docklocs for *removable dentures for 4 implants in the lower jaw and 6 implants in the upper jaw

Example of implant

Regular Ø3.5 x 8 mm

SB
Ø 3.5 mm

14 mm
12 mm
10 mm

0.6 mm collar height

Endosseous depth 9 mm

1 mm

Note: If the implant is placed 0.6 mm supracrestal, the drill and thread cutter must be drilled 1 mm deeper. A profile drill (XT35630) is also required.

Endosseous Ø3.5 mm

SB
Ø 3.5 mm

Important!

With Ø3.5 mm implants, do not exceed a torque of 45 Ncm.

Caution!

Use the tap according to the bone quality.

*Our alternative to the LOCATOR® technique

Surgical phase

Drill protocol $\varnothing 4.2$ mm RB

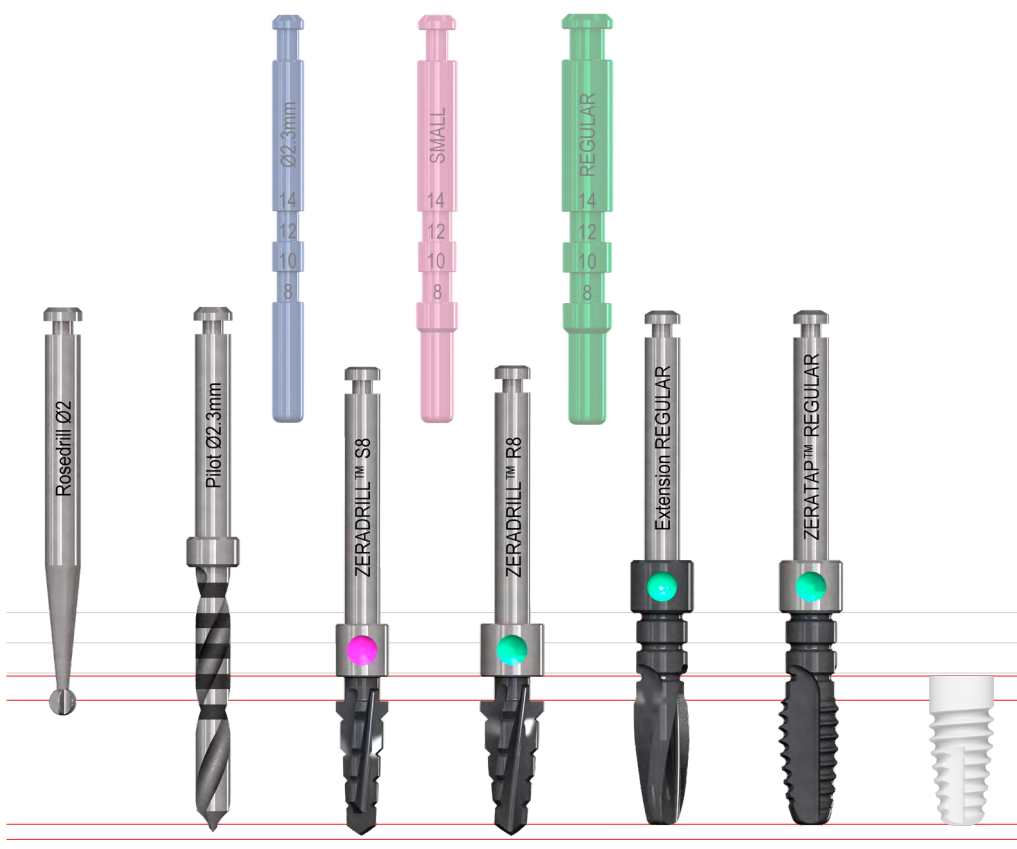

Example of implant
Regular $\varnothing 4.2 \times 8$ mm

RB
 $\varnothing 4.2$ mm

Rosedrill $\varnothing 2,3$ mm
max. 800 U/min

Zeradrill Pilot $\varnothing 2,3$ mm
max. 800 U/min

Zeradrill S8 (Small 8 mm)
max. 700 U/min

Zeradrill R8 (Regular 8 mm)
max. 600 U/min

Optional for hard bone
Zeradrill Extension Wide
max. 600 U/min

Zeratap Wide $\varnothing 4,2$ mm
max. 15 U/min

Zeramex XT RB
 $\varnothing 5,5$ mm x 8 mm

14 mm
12 mm
10 mm
1.6 mm collar height
Endosseous depth 8 mm
1 mm

Note: Optionally, the implant can also be positioned 0.6 mm supracrestal (instead of 1.6 mm). The drill and thread cutter must be drilled 1 mm deeper in this case.

Endosseous $\varnothing 4.2$ mm

RB
 $\varnothing 4.2$ mm

Important!
With $\varnothing 4.2$ mm implants, do not exceed a torque of 45 Ncm.

Caution!
Use the tap according to the bone quality.

Surgical phase

Drill protocol $\varnothing 5.5$ mm WB



Example of implant

Wide $\varnothing 5.5 \times 8$ mm



14 mm
12 mm
10 mm
1.6 mm collar height
Endosseous depth 8 mm
1 mm

Rosedrill $\varnothing 2$ mm
max. 800 U/min

Zeradrill Pilot $\varnothing 2.3$ mm
max. 800 U/min

Zeradrill S8 (Small 8 mm)
max. 700 U/min

Zeradrill R8 (Regular 8 mm)
max. 600 U/min

Zeradrill W8 (Wide 8 mm)
max. 500 U/min

Optional for hard bone
Zeradrill Extension Wide
max. 500 U/min

Zeradrill Wide $\varnothing 5.5$ mm
max. 15 U/min

Zeremex XT WB
 $\varnothing 5.5$ mm x 8 mm

Note: Optionally, the implant can also be positioned 0.6 mm supracrestal (instead of 1.6 mm). The drill and thread cutter must be drilled 1 mm deeper in this case.

Endosseous $\varnothing 5.5$ mm

Important!

With $\varnothing 5.5$ mm implants, do not exceed a torque of 45 Ncm.

Caution!

Use the tap according to the bone quality.

Surgical phase

Handling



1.

1. Contents
Box contents: Implant in a spherical packaging with matching healing cap.

Important!
Check the required implant dimensions before opening the package.

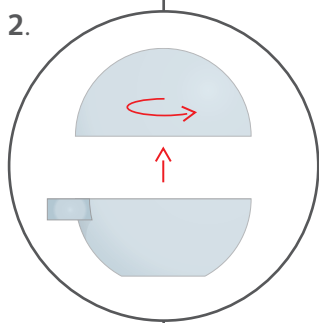

2.

2. Open sphere
Open the sphere by twisting.

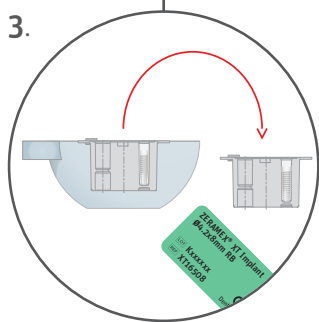

3.

3. Remove
Remove the sterile secondary blisters (low microbial contamination) and patient labels from the sphere.

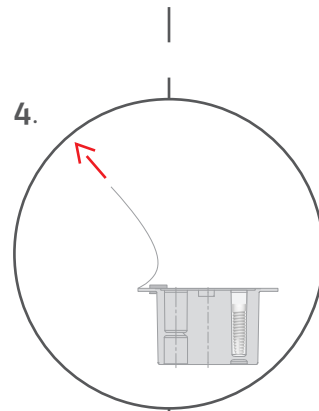

4.

4. Open blister
Break the seal shortly before use (interior is sterile).

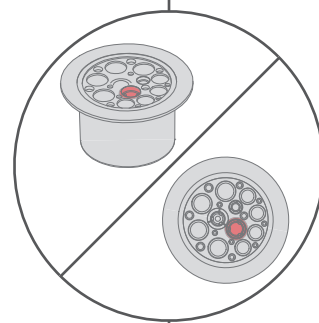

5.

Important!
The healing cap designed to match the implant is also included in the sterile secondary blister in the designated cavity.



5. Pick up implant
Pick up the implant using the pick-up tool (insert in the ratchet adapter; snap in the square socket). It is recommended to put the Healing Cap on the sterile area and to pick up the implant using the prosthetic key or pick-up.

Required material
Pick-up (XT36620/XT36625),
Ratchet Adapter Unit Short (P48932)

Surgical phase

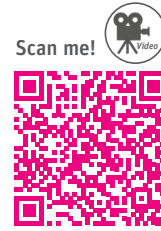

Implant

Insert

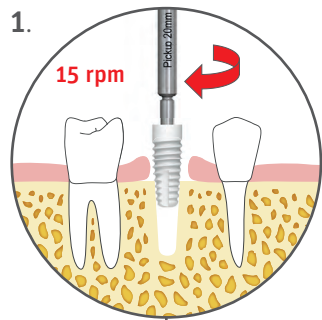

1. Screw in
Slowly screw the implant into the pre-cut drill hole.

Important!
Never use the rescue pick-up for insertion.

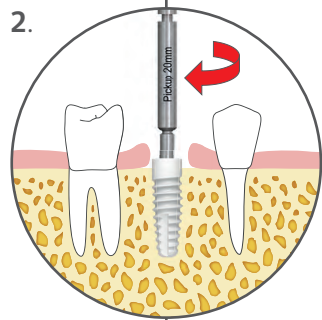

2. Tighten
Tighten the implant using the ratchet.
Recommendation: 20 - 30 Ncm
SB max. 35 Ncm
RB/WB max. 45 Ncm

Important!
Due to the conical design, torque is only exerted in the last two rotations.

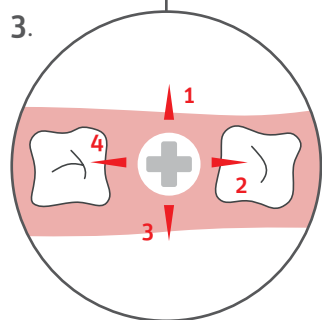

3. Positioning
◀ = The arrows show the possible positions of the angled abutment. Take this into account when inserting the implant.

Comply with protocol torque

The maximum torque for all SB implants is **35 Ncm**. The maximum torque for RB and WB implants is **45 Ncm**. Never exceed this torque. The pick-up has a predetermined breaking point of approximately 50 Ncm. Maximum speed: **15 rpm**.

Seal

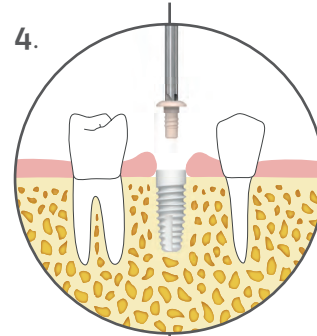

4. Seal
Seal the implant with the healing cap using the prosthetic key (XT38619/XT38623/XT38628) and carefully tighten the healing cap (**max. 5 Ncm**).

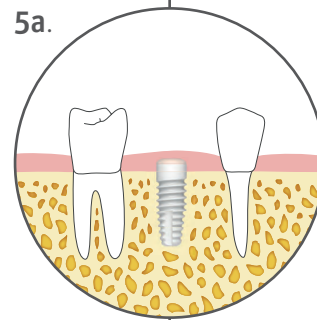

5a. Version 1
Closed healing (recommended).

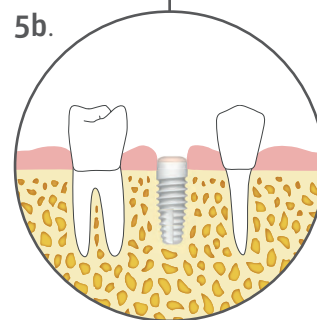

5b. Version 2
Open healing; note closely adjacent gingiva.

Zeramex XT

Prosthetic restoration



Soft tissue management

Gingiva former

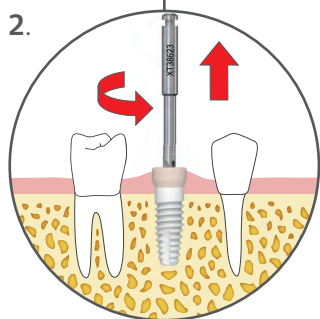
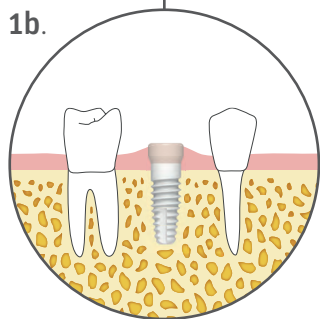
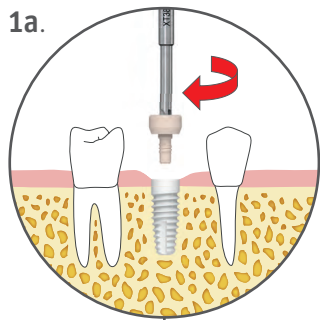

Comply with protocol torque

Force does not need to be applied to insert the gingiva former. Carefully screw in to the full depth.

1a/b. Insert

Place the gingiva former on the prosthetic key and carefully screw in clockwise to the full depth under slight pressure. **(max. 5 Ncm).**

2. Remove

To remove the gingiva former, insert the prosthetic key and turn counterclockwise.

Required material

Gingiva former (SB35503/SB35504/RB36503/RB36504/WB37503/WB37504),

Prosthetic key (XT38619/XT38623/XT38628)

Temporary restoration

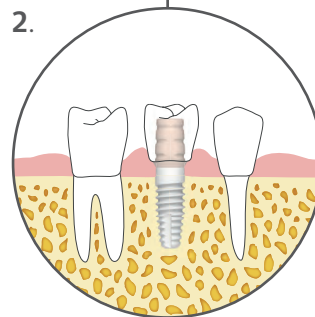
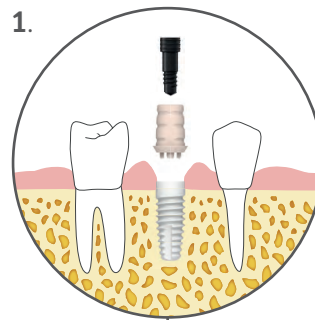

1. Position

Position the temporary abutment and tighten with the prosthetic key **(max. 15 Ncm).**

Important!

The maximum wearing time of the temporary abutment is **180 days.**

General information

Bear in mind that polymer prosthetic components have a different feel than metal to the user. Familiarise yourself with this beforehand.

2. Process

If necessary, work on the provisional extra-orally and provide it with a provisional crown.

Processing the provisional restoration

It is preferable to machine the polymer with fine-grain diamond-coated instruments at a high speed. This is done extra-orally with slight pressure and effective cooling.

Required material

Provisional restoration (SB35530/RB36530/WB37530),
Prosthetic key (XT38619/XT38623/XT38628)

Conventional impression taking

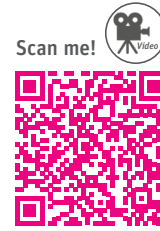

Open tray

In the surgery

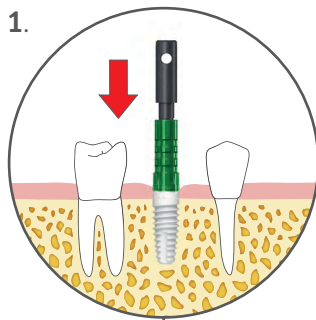

1. Position
Place the locking pin with the transfer sleeve on the implant shoulder under slight pressure while turning until it snaps into the hex head socket, rests securely on the implant shoulder, and can no longer be rotated.

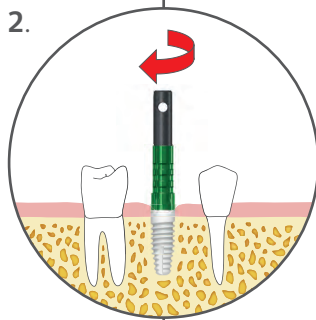

2. Screw tight
Secure the transfer sleeve with one hand. Tighten the locking pin clockwise by hand, and check the position for a form-fit. In case of doubt, take an X-ray.

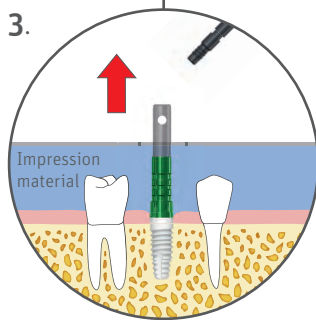

3. Taking an impression
Create the impression with an open tray. Unscrew and remove the locking pin. Remove the impression and send with the locking pin to the dental technician.

Important!

The transfer sleeves must be snapped into the inner edge and mate securely. To check, apply a slight counter-movement.

In the laboratory

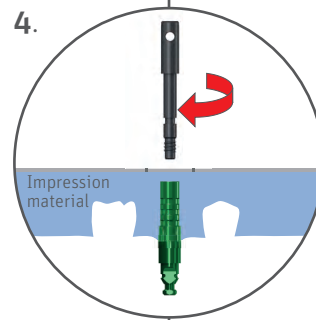

4. Connecting
Position the transfer sleeve on the replica shoulder under slight pressure while twisting until it snaps into the hex head socket of the implant replica, rests securely on the shoulder and can no longer be rotated. Tighten the locking pin clockwise by hand.

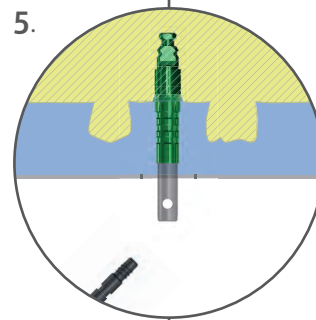

5. Creating model
Check that the transfer with the screw-fitted implant replica is securely seated. Create master model. Remove the locking pin before removing the impression.

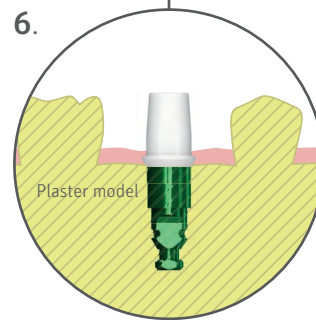

6. Restoration
Select an abutment based on the prosthetic requirements and the preferred surgical method. Straight and angled abutments are available, along with Zeramex Docklocs® Abutments (from page 31).

Required material

Transfer Open Tray (SB35510/RB36510/WB37510), **Implant Replica** (SB35522/RB36522/WB37522)

Information!

The four **retaining elements** of the implant must be correctly aligned when selecting an **angled abutment** (User Instructions Surgery, page 24, fig. 3).

Conventional impression taking

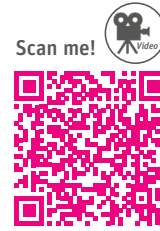

Closed tray

In the surgery

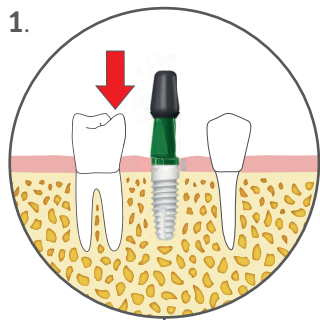

1. Positioning
Place the transfer sleeve on the implant shoulder under slight pressure while turning until it snaps into the hex head socket, rests securely on the implant shoulder, and can no longer be rotated.

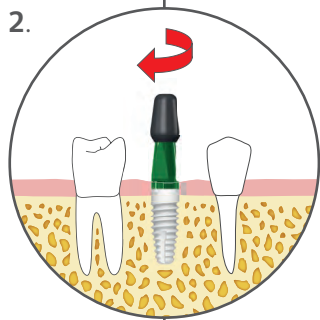

2. Tighten
Tighten the locking pin clockwise by hand, and check the position for a form-fit.

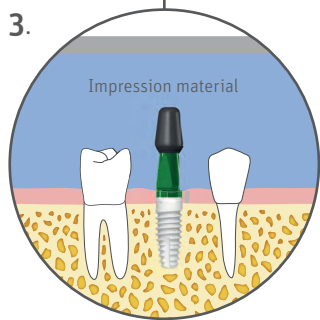

3. Taking an impression
Take an impression with a closed tray and remove. Unscrew the locking pin, remove the transfer from the implant and send to the dental technician with the impression.

Important!
The transfer sleeves must be snapped into the inner edge and mate securely. To check, apply a slight counter-movement.

Caution!
Closed impression taking is not recommended for the front section of the maxilla or in the case of angulation greater than 15°.

In the laboratory

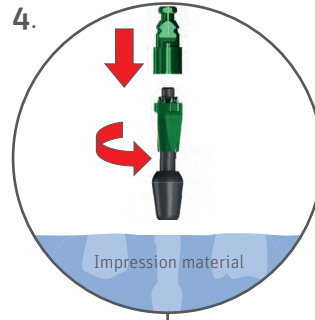

4. Connecting
Position the transfer sleeve on the replica shoulder under slight pressure while twisting until it snaps into the hex head socket of the implant replica, rests securely on the shoulder and can no longer be rotated. Tighten the locking pin clockwise by hand.

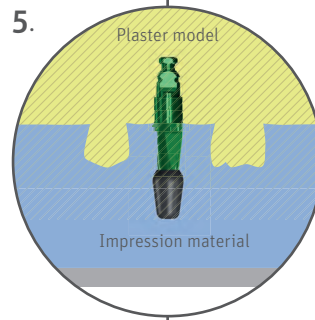

5. Repositioning and creating model.
Reposition the transfer with the screw-fitted implant replica and check that it is securely seated. Create master model.

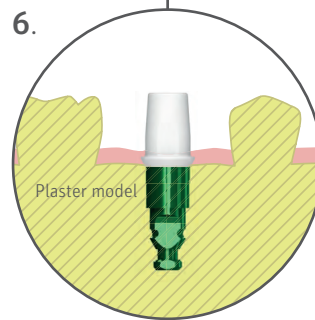

6. Restoration
Select an abutment based on the prosthetic requirements and the preferred surgical method. Straight and angled abutments are available, along with Zeramex Docklocs® Abutments (from page 31).

Required material
Transfer Closed Tray (RB36512/WB37512) or (RB36513/WB37513), Implant Replica (SB35522/RB36522/WB37522)

Prosthetic process

Field of use

Information on fields of use and indications is available in the instructions for use (IFU) at www.zeramex.com.

1 Preparation phase

Prosthetic restoration is governed by the overall approach for achieving the best possible results. Integral functionality, aesthetics and patient comfort are the primary considerations. A detailed dental analysis (including X-rays) taking into account the patient's medical history is the foundation for this. Create the treatment plan based on the main considerations.

2 Gingiva management

A “pink” appearance reflects healthy gums. It is essential to treat any gum disorders in advance. Soft tissue grows well around zirconium oxide, which is of great relevance, especially in the anterior region. A natural emergence profile is individually created using a gingiva former or a provisional, and the “black triangle” is a thing of the past.

3 Abutment/implant connection

There are two basic pathways to metal-free, aesthetically and biologically flawless restoration:

- Screwed prosthetic restoration (page 31)
- Cemented prosthetic restoration (page 35)

The range of metal-free prosthetics is extensive and satisfies the stringent requirements with regard to aesthetics and functionality. The Zeramex XT implant with its various abutments is ideal for nearly every situation.

4 Workflow

The Zeramex XT implant system seamlessly integrates with conventional procedure using manual, direct and indirect impressions.



The prosthetic parts marked pink are for the SB platform (3.5 mm implant).



The prosthetic parts marked green are for the RB platform (4.2 mm implant).



The prosthetic parts marked yellow are for the WB platform (5.5 mm implant).

Note: The exceptions are the screws (RB16550/RB36554/RB36550). Please note the information on pages 41-43.



Vicarbo
Screw
RB16550

Try-In
Screw
RB36554

Provisional
Screw
RB36550

Docklocs® is a registered trademark of MEDEALIS GmbH and our alternative to the LOCATOR® technique.

Prosthetic tools

Important!

Products must be secured against aspiration when handled intraorally!



Ratchet

Important!

Always store the ratchet untightened.

Surgical Ratchet (P48935)



Adapter Unit Short (P48932)



Prosthetic key

Prosthetic key 19 mm (XT38619)



Prosthetic key 23 mm (XT38623)



Prosthetic key 28 mm (XT38628)



Prosthetic kit

Prosthetic kit (XT48860)

Prosthetic kit, incl. Ratchet (XT48865)

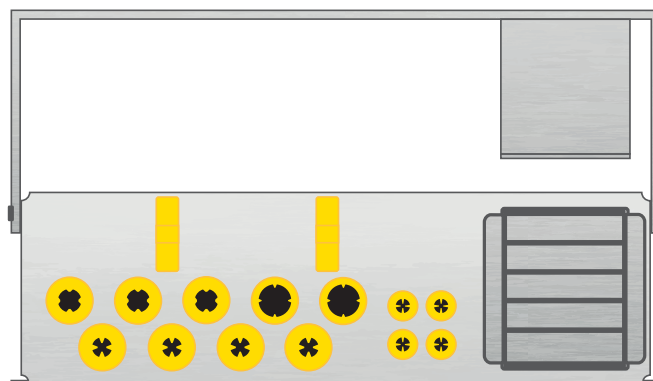

Screwed connection



Abutments

Straight (in two collar heights) and angled abutments are available for the implants 3.5 mm (SB), 4.2 mm (RB) and 5.5 mm (WB).

1 mm
Straight



2 mm
Straight



1 mm
Angular

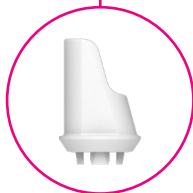

Vicarbo screw

The strong screw made of high performance polymer reinforced with carbon fibre.



Screwed prosthetic restoration

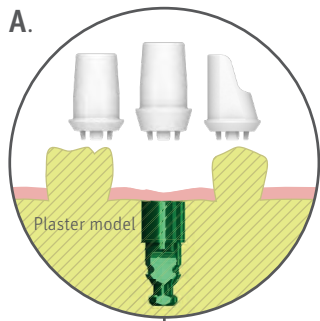

A. Select the suitable abutment.

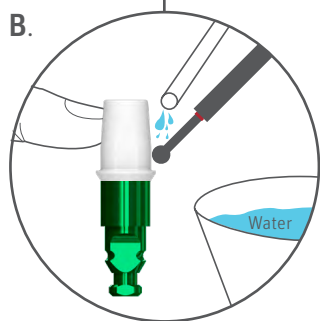

B. If necessary, individually machine the abutment. Only process the abutment under sufficient, continuous cooling with slight pressure. Local overheating causes micro-fissures and destruction of the abutment.

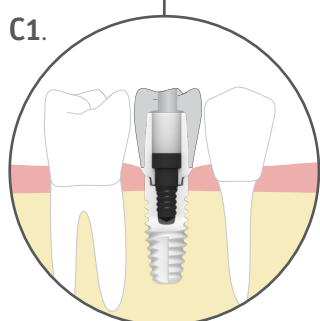

C1. All XT abutments are approved for the following: Adhesion, milling and pressing. You can choose a monolithic crown (C1) or a full-ceramic crown on a zirconium dioxide cap (C2).

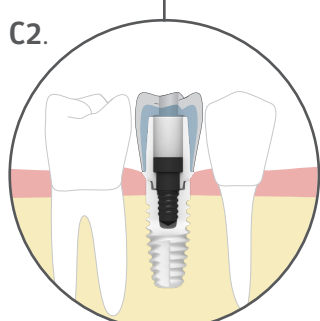

C2. All XT abutments are approved for the following: Adhesion, milling and pressing. You can choose a monolithic crown (C1) or a full-ceramic crown on a zirconium dioxide cap (C2).

A. Select the suitable abutment.

B. If necessary, individually machine the abutment. Only process the abutment under sufficient, continuous cooling with slight pressure. Local overheating causes micro-fissures and destruction of the abutment.

Important! Please note the information on machining abutments on page 40!

C. All XT abutments are approved for the following: Adhesion, milling and pressing. You can choose a monolithic crown (C1) or a full-ceramic crown on a zirconium dioxide cap (C2).

C1. Monolithic crowns made of various optimised polymers or zirconium dioxide.

C2. All-ceramic crowns made of layered or pressed ceramic on a zirconium dioxide cap.

Fabricating supraconstructions in the laboratory

The Zeramex XT system offers reversible screwing into zirconium dioxide. The internal thread makes it possible to screw prosthetic parts and zirconium dioxide abutments into implants. The anti-rotation protection on the platform allows secondary parts to be securely and precisely positioned, and the laboratory screw ensures that they are firmly seated.

Everything you need for the laboratory at a glance

- Every abutment is supplied with the appropriate Vicarbo screw.
- Every Vicarbo screw may only be tightened once up to the maximum torque.
- The torque for the **Vicarbo screw** for the SB/RB/WB platform is always **min. 20 Ncm / max. 25 Ncm!**
- For work in the laboratory, we offer **laboratory screws** that may not be tightened more than **5 Ncm.**
- Adapt your approach to the anatomical situation and do not use over-dimensioned crowns or connections to natural teeth (hybrid restoration).
- Do not use “floating crown attachments” with an abutment.
- When grinding the abutment, an additional replica can be used as a holder. Counterpressure with the fingers reduces vibration.

Tip: Use an individual positioning wrench for angled abutments or complex restorations

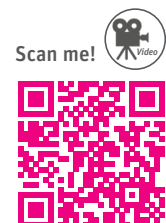

Important! It is essential to consider the minimum layer thickness according to the manufacturer’s instructions for the specific crown material.

Screwed prosthetic restoration

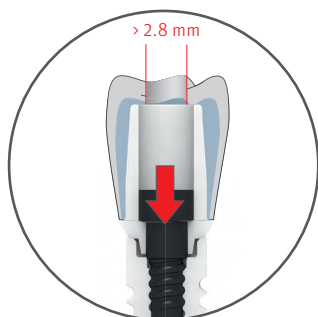

The diameter of the screw channel for the Vicarbo screw for the **SB/RB/WB platform must be > 2.8 mm.**



The diameter of the screw channel for the reduced-diameter version must be **> 2.2 mm.**

Caution!

When sealing the screw channel, do not use any gels or liquids containing chlorine.

Occlusal screwed connection in the patient's mouth

Restoration with placeholders

When using placeholders, make sure that the screw channel diameter allows the Vicarbo screw to be inserted into and removed from the abutment and crown at any time, even when the crown is already tightly cemented to the abutment.

You can make your own positioning aids/placeholders:
SB/RB/WB platform: > 2.8 mm

Screw channel with a reduced diameter

You can also use screw channels with a reduced diameter instead of placeholders. With this, the screw channel diameter can be reduced to **> 2.2 mm**. The prosthetic key (XT38619/XT38623/XT38628) can be used as a placeholder.

Important!

- When using reduced-diameter screws, the Vicarbo screw must be inserted in the abutment in the laboratory before the crown is secured onto the abutment.
- The Vicarbo screw cannot be screwed in or out after the crown has been cemented.
- When cementing the crown, excess cement must not enter the screw channel of an inserted screw (insert cotton wad or a similar placeholder that can be removed from the screw channel).
- If the abutment is shortened, make sure that the Vicarbo screw has sufficient vertical space to be screwed in and out.

Screwed prosthetic restoration

Comply with protocol torque

The unique torque for the Vicarbo screw for all platforms is **(SB/RB/WB): min. 20 Ncm / max. 25 Ncm.**

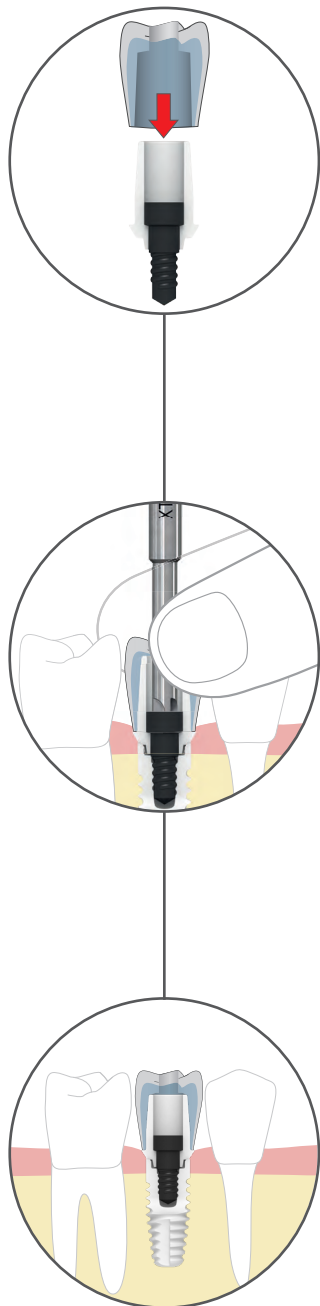

Occlusal screwed connection in the patient's mouth

1a.

The cap can be veneered by pressing or layering. Select the diameter of the screw channel for later screwing depending on the procedure:

- SB/RB/WB abutments: > 2.8 mm
- **Reduced diameter: > 2.2 mm***

*Important!

When using reduced-diameter screws, the screw must be inserted in the abutment before the crown is cemented onto the abutment. Please note the information on page 33.

1b.

Place the abutment with the cemented crown on the implant. Apply slight pressure to fit the abutment/crown until it snaps into place in the correct position. Hold the abutment/crown and tighten the screw in the screw channel by applying pressure from the occlusal direction. **Use the prosthetic key and the torque ratchet (SB/RB/WB: min. 20 Ncm / max. 25 Ncm).** Use a probe and/or X-ray to check if the abutment is correctly seated.

Required material

Abutment incl. Vicarbo screw (SB15501/SB15502/SB15515), (RB16501/RB16502/RB16515), (WB17501/WB17502/WB17515), **Prosthetic key** (XT38619/XT38623/XT38628)

Cemented prosthetic restoration

Comply with protocol torque

The unique torque for the Vicarbo screw for all platforms is **(SB/RB/WB): min. 20 Ncm / max. 25 Ncm.**



2a.

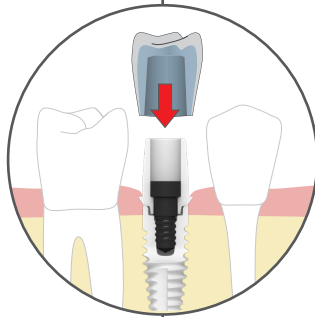

2b.

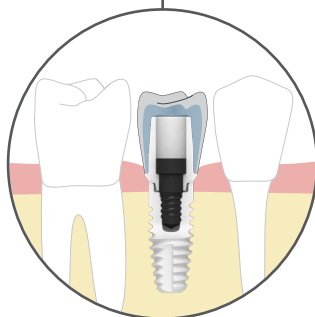

Cementing the crown in the patient's mouth

Note: If a screw channel is not possible or required, the crown can be produced in the laboratory without a screw channel.

2a.

The Vicarbo screw is picked up with the prosthetic key and inserted into the abutment. The abutment can now be transferred onto the implant with the prosthetic key.

Note: Hold the abutment and screw tight > No locking! Before tightening the screw, press it downward. Use the prosthetic key and the torque ratchet to tighten the screw. **(SB/RB/WB: min. 20 Ncm / max. 25 Ncm).** Use a probe and/or X-ray to check if the abutment is correctly seated.

Note: An individual positioning wrench may need to be made.

2b.

The cap can be veneered by pressing or layering. Cement the finished crown onto the tightly screwed abutment, and remove any excess cement.

Note: There is a specific Vicarbo Zeramex Screw for each abutment. Please note the technical data for Zeramex screws on pages 41-43.

Required material

Abutment incl. Vicarbo screw (SB15501/SB15502/SB15515), (RB16501/RB16502/RB16515), (WB17501/WB17502/WB17515), Prosthetic key (XT38619/XT38623/XT38628)

Platform switching

To prevent potential crestal bone loss or to increase the soft tissue volume around the implant platform, the excellent prosthetic flexibility of the Zeramex XT system allows platform switching with two options available.



1. 
Zeramex XT SB Abutments
 SB15501/SB15502/SB15515



Zeramex XT RB Implants
 XT16508/XT16510/XT16512/XT16514



Examples
 SB 15501
 XT16510

2. 
Zeramex XT RB Abutments
 RB16501/RB16502/RB16515



Zeramex XT WB Implants
 XT17508/XT17510/XT17512



Examples
 RB 16501
 XT17510

Zeramex XT Platform Switching options

1. It is possible to place a Zeramex XT SB abutment (SB15501/SB15502/SB15515/SB15535/SB15536/SB15551) on any Zeramex XT RB implant (XT16508/XT16510/XT16512/XT16514).

2. It is possible to place a Zeramex XT RB abutment (RB16501/RB16502/RB16515/RB16535/RB16536/RB16530/RB16531/RB16551) on any Zeramex XT WB implant (XT17508/XT17510/XT17512).

Caution!

There is no option for platform switching for Zeramex XT WB implants with Zeramex XT SB abutments.

Zeramex Docklocs® Abutments

Comply with protocol torque

The unique torque for the Vicarbo screw of the Docklocs® Abutments for all platforms is **(SB/RB/WB): max. 15 Ncm.**

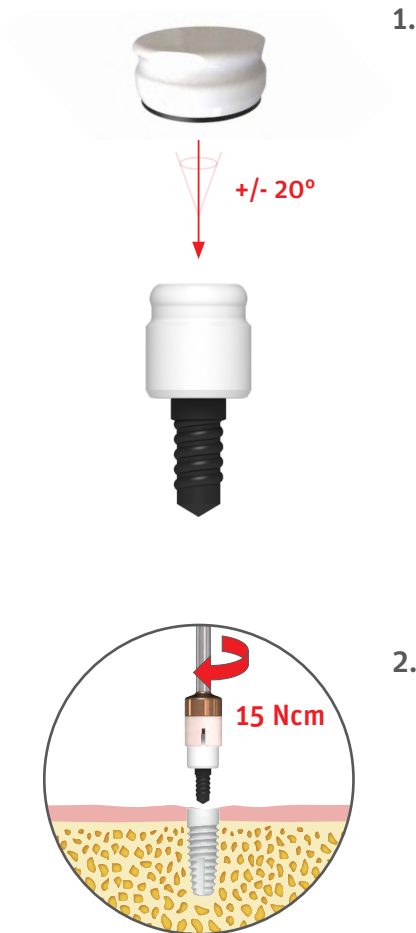

Sequence

Zeramex Docklocs® is a pre-finished connection system to secure removable restorations based on a snap connection.

Note: Zeramex Docklocs® Abutments are available in three heights (2 mm/3 mm/4 mm) and fit on all platforms (SB/RB/WB).

1. Divergences

The Zeramex Docklocs® system offers the option of integrating a dental prosthesis for implantation that diverges by up to 20°. This means that deviations between two implants of **up to 40°** can be corrected.

2. Insert the Zeramex Docklocs® Abutment

Ensure that the implant shoulder is not covered by hard or soft tissue. Screw the Zeramex Docklocs® Abutment with the Zeramex Docklocs® Insertion Instrument (XT38227) into the implant and tighten by hand. Tighten the abutment with the ratchet, the ratchet adapter and the Zeramex Docklocs® Insertion Instrument to **15 Ncm.**

Note: Horizontal alignment of all Zeramex Docklocs® Abutments makes the insertion of the prosthesis easier for the patient.

Zeramex Docklocs® Abutments

Technical data

The Zeramex Docklocs® system consists of a Zeramex Docklocs® Abutment, the matching insertion instrument, a Zeramex Docklocs® housing, a Zeramex Docklocs® blockout ring, a Zeramex Docklocs® lab analogue, a Zeramex Docklocs® impression post and three exchangeable Zeramex Docklocs® polyamide retention inserts (PA12) with different colour-coded retention values and pull-off forces.



Zeramex Docklocs® Abutments (2 mm/3 mm/4 mm)



Zeramex Docklocs®
Abutment 2 mm
(SB15542)

Zeramex Docklocs®
Abutment 3 mm
(SB15543)

Zeramex Docklocs®
Abutment 4 mm
(SB15544)

Zeramex Docklocs® Insertion Instrument

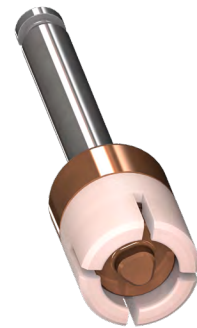

Zeramex Docklocs®
Insertion instrument
(XT38227)

Zeramex Docklocs® Retention inserts



Red: 0.45 kg
(Extra-light retention)
(XT38205)

Orange: 0.91 kg
(Light retention)
(XT38206)

Green: 1.81 kg
(Strong retention)
(XT38207)

Note: The Zeramex Docklocs® retention inserts can be exchanged without tension using a conventional assembly and disassembly instrument for retention inserts.

Docklocs® is a registered trademark of MEDEALIS GmbH and our alternative to the LOCATOR® technique.

Zeramex Docklocs® Zirconium Housing



Zeramex Docklocs®
Zirconium Retention Housing
(XT38230)

Technical data for Zeramex XT abutments

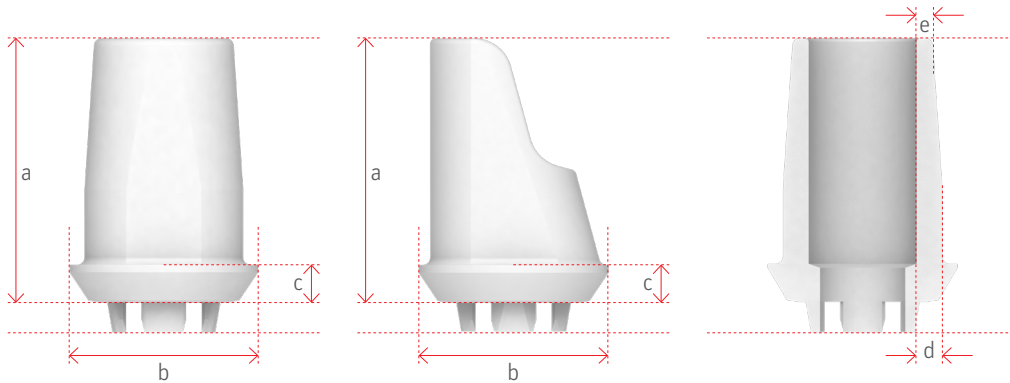

		a	b	c	d	e	
SB ø3.5mm	SB15501	Zeramex XT Abutment SB Straight, 1 mm	7.0	4.6	1.0	0.7	0.6
	SB15502	Zeramex XT Abutment SB Straight, 2 mm	8.0	4.6	2.0		
	SB15515	Zeramex XT Abutment SB Angular 15°, 1 mm	7.0	4.6	1.0		

All dimensions in millimetres

		a	b	c	d	e	
RB ø4.2mm	RB16501	Zeramex XT Abutment RB Straight, 1 mm	7.0	5.0	1.0	0.7	0.6
	RB16502	Zeramex XT Abutment RB Straight, 2 mm	8.0	5.0	2.0		
	RB16515	Zeramex XT Abutment RB Angular 15°, 1 mm	7.0	5.0	1.0		

All dimensions in millimetres

		a	b	c	d	e	
WB ø5.5mm	WB17501	Zeramex XT Abutment WB Straight, 1 mm	7.0	6.0	1.0	0.7	0.6
	WB17502	Zeramex XT Abutment WB Straight, 2 mm	8.0	6.0	2.0		
	WB17515	Zeramex XT Abutment WB Angular 15°, 1 mm	7.0	6.0	1.0		

All dimensions in millimetres

Grinding Standard Abutments

Comply with protocol torque

The unique torque for the Vicarbo screw for all platforms is **(SB/RB/WB): min. 20 Ncm / max. 25 Ncm.**



Example of abutment

Zeramex XT Abutment RB Straight, 1 mm RB16501

Material

ZrO₂ ATZ-HIP

Composition:

- ZrO₂: 76%
- Al₂O₃: 20%
- Y₂O₃: 4%

Flexural strength: 2,000 MPa

CTE for ZrO₂ ATZ: 9 × 10⁻⁶/K

Procedure

- Conical part **(4.0 mm)** may be shortened.
- Only process under sufficient, continuous water cooling with slight pressure.
- Use high speed **(water-cooled turbine)** and fine grain size (red-ring diamond, smaller than 50 µm).

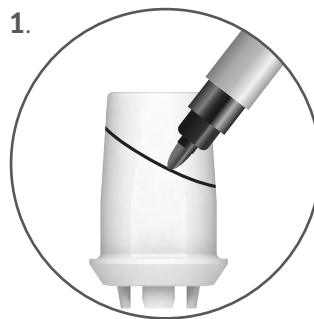

1. Marking (record) of the "Preparation process"

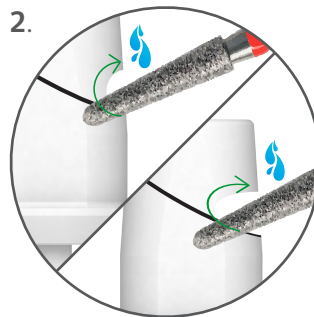

2. Adequate procedure with handpiece: Lightly encircle the preparation position, then expand it in a vertical, V-shaped movement until it is cut through.

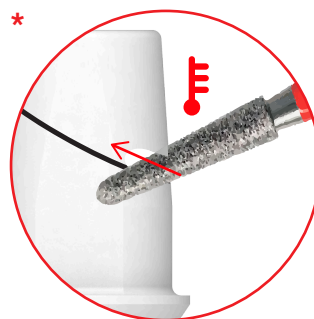

*** Caution!**
Do not cut through zirconium dioxide that is the same thickness of the instruments or grinding tool.

Risk of overheating!

Technical data for Zeramex XT screws

Important distinguishing feature of Zeramex XT screws:

- The Try-In Screw and Vicarbo Screw have no grooves on the screw head and are shorter than the Provisional Screw
- The screw head diameter for all screws is 2.8 mm
- All screws are suitable for Small (SB), Regular (RB) and Wide Base (WB).

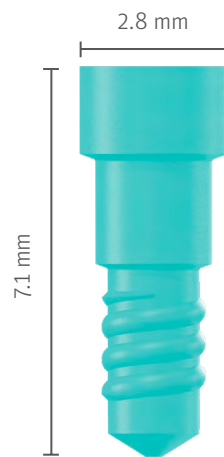

Vicarbo Screw

RB16550

Matches:

SB/RB/WB Abutment

Distinguishing feature:

Length: 7.4 mm
No grooves on screw head
Black

Tightening torque:

min. 20 Ncm
max. 25 Ncm

Material:

Vicarbo

Caution:

This screw is intended for the final treatment and may only be used once! It can be tried on with a max. 15 Ncm torque.

Try-In Screw

RB36554

Matches:

SB/RB/WB Abutment

Distinguishing feature:

Length: 7.1 mm
No grooves on screw head
Green

Tightening torque:

5 Ncm

Material:

PEEK

Caution:

This screw may only be used in the laboratory and not for the definitive fit!

Provisional Screw

RB36550

Matches:

SB/RB/WB provisional

Distinguishing feature:

Length: 8.6 mm
Ring on screw head
Black

Tightening torque:

15 Ncm

Material:

Vicarbo

Caution:

This screw may only be used for the temporary restoration!

Technical data for Zeramex XT screws

Vicarbo Screw

(RB16550)

Tightening torque:

min. 20 Ncm

max. 25 Ncm



Try-In Screw

(RB36554)

Tightening torque:

5 Ncm



Provisional Screw

(RB36550)

Tightening torque:

15 Ncm



SB
ø3.5mm

RB
ø4.2mm

WB
ø5.5mm

SB
ø3.5mm

RB
ø4.2mm

WB
ø5.5mm



SB straight, 1 mm
(SB15501)



RB straight, 1 mm
(RB16501)



WB straight, 1 mm
(WB17501)



SB Provisional
(SB35530)



RB Provisional
(RB36530)



WB Provisional
(WB37530)



SB straight, 2 mm
(SB15502)



RB straight, 2 mm
(RB16502)



WB straight, 2 mm
(WB17502)



SB Angular, 1 mm
15° (SB15515)



RB Angular, 1 mm
15° (RB16515)



WB Angular, 1 mm
15° (WB17515)

The metal-free innovation: Vicarbo screw

Our objective was to offer a 100% metal-free solution in which not only the implant but also the screw are metal-free. We therefore decided to use the high-performance material Vicarbo. Vicarbo is a carbon-fibre reinforced PEEK plastic, in which the carbon fibres are aligned with the longitudinal axis of the material. In this way, we can achieve enormous strength. Thanks to the production process developed by Zeramex, the carbon fibres are not damaged during production and they retain their full function. This screw is unique in dental implantology.

This material has already proved its worth in other medical applications (e.g. orthopaedics) and is considered to be the material of the future. Aerospace engineers also use carbon fibre reinforced components because of their enormous strength and low weight.



Technical specifications

- Flexural modulus: >130 GPa
- Flexural strength: >900 MPa

Sterilisation method

- Steam sterilisation at 132 °C / 270 °F or 134 °C / 274 °F / Time: 18 minutes

Do I have to keep the specified tightening torques?

The specified tightening torque must be used to compensate the reduced tension through the tight fit and to ensure a reliable, permanent bond.

Why does the Vicarbo screw have a conical shoulder?

The conical shoulder of the screw was designed so that the fit with the abutment is as tight as possible without generating lateral forces that could damage the abutment later.

What material is the Vicarbo screw made from?

Why is it black?

The screw is made of PEEK plastic reinforced with longitudinally aligned carbon fibres. The carbon fibres are responsible for the Vicarbo screw's colour.





Zeramex XT Range









Range

XT

Zeramex XT Implants

SB Ø3.5 mm	Art. No.	Name	Dimension	Material
	XT15508	Zeramex XT Implant Ø3.5×8 mm SB (incl. Healing Cap)	Length: 8 mm	ZrO ₂ -ATZ-HIP
	XT15510	Zeramex XT Implant Ø3.5×10 mm SB (incl. Healing Cap)	Length: 10 mm	
	XT15512	Zeramex XT Implant Ø3.5×12 mm SB (incl. Healing Cap)	Length: 12 mm	

RB Ø4.2 mm	Art. No.	Name	Dimension	Material
	XT16508	Zeramex XT Implant Ø4.2×8 mm RB (incl. Healing Cap)	Length: 8 mm	ZrO ₂ -ATZ-HIP
	XT16510	Zeramex XT Implant Ø4.2×10 mm RB (incl. Healing Cap)	Length: 10 mm	
	XT16512	Zeramex XT Implant Ø4.2×12 mm RB (incl. Healing Cap)	Length: 12 mm	
	XT16514	Zeramex XT Implant Ø4.2×14 mm RB (incl. Healing Cap)	Length: 14 mm	

WB Ø5.5 mm	Art. No.	Name	Dimension	Material
	XT17508	Zeramex XT Implant Ø5.5×8 mm WB (incl. Healing Cap)	Length: 8 mm	ZrO ₂ -ATZ-HIP
	XT17510	Zeramex XT Implant Ø5.5×10 mm WB (incl. Healing Cap)	Length: 10 mm	
	XT17512	Zeramex XT Implant Ø5.5×12 mm WB (incl. Healing Cap)	Length: 12 mm	

Zeramex XT Abutments

SB Platform	Art. No.	Name	Dimension	Material
	SB15501	Zeramex XT Abutment SB Straight, 1 mm (incl. screw)	AH: 7 mm CH: 1 mm Ø: 4.6 mm	ZrO ₂ -ATZ-HIP Vicarbo
	SB15502	Zeramex XT Abutment SB Straight, 2 mm (incl. screw)	AH: 8 mm CH: 2 mm Ø: 4.6 mm	
	SB15515	Zeramex XT Abutment SB Angular 15°, 1 mm (incl. screw)	AH: 7 mm CH: 1 mm Ø: 4.6 mm	

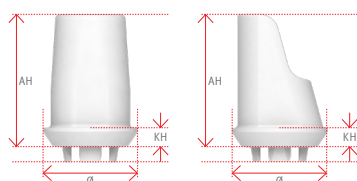



AH: Abutment height
CH: Collar height
Ø: Diameter

SB/RB/WB Vicarbo Screw	Art. No.	Name	Dimension	Material
	RB16550	Zeramex XT (SB/RB/WB) Vicarbo screw, Straight/Angular	Length: 7.4 mm	Vicarbo

Range

XT

Zeramex XT Abutments

RB Platform	Art. No.	Name	Dimension	Material
	RB16501	Zeramex XT Abutment RB Straight, 1 mm (incl. screw)	AH: 7 mm CH: 1 mm Ø: 5 mm	ZrO ₂ -ATZ-HIP Vicarbo
	RB16502	Zeramex XT Abutment RB Straight, 2 mm (incl. screw)	AH: 8 mm CH: 2 mm Ø: 5 mm	
	RB16515	Zeramex XT Abutment RB Angular 15°, 1 mm (incl. screw)	AH: 7 mm CH: 1 mm Ø: 5 mm	

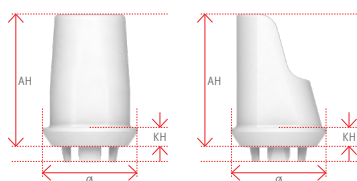

AH: Abutment height
CH: Collar height
Ø: Diameter

SB/RB/WB Vicarbo Screw	Art. No.	Name	Dimension	Material
	RB16550	Zeramex XT (SB/RB/WB) Vicarbo screw, Straight/Angular	Length: 7.4 mm	Vicarbo

Zeramex XT Abutments

WB Platform	Art. No.	Name	Dimension	Material
	WB17501	Zeramex XT Abutment WB Straight, 1 mm (incl. screw)	AH: 7 mm CH: 1 mm Ø: 6 mm	ZrO ₂ -ATZ-HIP Vicarbo
	WB17502	Zeramex XT Abutment WB Straight, 2 mm (incl. screw)	AH: 8 mm CH: 2 mm Ø: 6 mm	
	WB17515	Zeramex XT Abutment WB Angular 15°, 1 mm (incl. screw)	AH: 7 mm CH: 1 mm Ø: 6 mm	

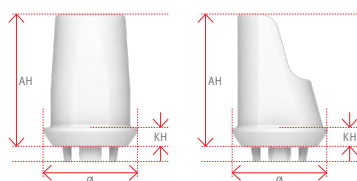





AH: Abutment height
CH: Collar height
Ø: Diameter



SB/RB/WB Vicarbo Screw	Art. No.	Name	Dimension	Material
	RB16550	Zeramex XT (SB/RB/WB) Vicarbo screw, Straight/Angular	Length: 7.4 mm	Vicarbo



Range

XT

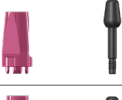
Zeramex Prosthetics

SB soft tissue management	Art. No.	Name	Dimension	Material
	SB35500	Zeramex XT Healing Cap SB	Height: 0.6 mm	PEEK
	SB35503	Zeramex XT Gingivaformer SB, 3 mm	Height: 3 mm Ø: 4 mm	
	SB35504	Zeramex XT Gingivaformer SB, 4 mm	Height: 4 mm Ø: 4 mm	
	SB35530	Zeramex XT Provisional SB (incl. screw)	AH: 7 mm CH: 1 mm Ø: 4 mm	PEEK Vicarbo



SB Impression Taking	Art. No.	Name	Dimension	Material
	SB35510	Zeramex XT Transfer Open Tray SB	High sleeve: 11 mm / height incl. screw: 20 mm	Aluminium PEEK-CW30
	SB35512	Zeramex XT Transfer Closed Tray SB	High sleeve: 7 mm / height incl. screw: 14 mm	
	SB35513	Zeramex XT Transfer Closed Tray, long SB	High sleeve: 11 mm / height incl. screw: 18 mm	
	SB35522	Zeramex XT Implant Replica SB	Length: 10 mm	Aluminium

RB soft tissue management	Art. No.	Name	Dimension	Material
	RB36500	Zeramex XT Healing Cap RB	Height: 0.6 mm	PEEK
	RB36503	Zeramex XT Gingivaformer RB, 3 mm	Height: 3 mm Ø: 5 mm	
	RB36504	Zeramex XT Gingivaformer RB, 4 mm	Height: 4 mm Ø: 5 mm	



Range

XT

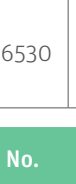
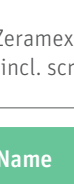
	RB36530	Zeramex XT Provisional RB (incl. screw)	AH: 7 mm CH: 1 mm Ø: 5 mm	PEEK Vicarbo
---	---------	--	---------------------------------	-----------------

RB Impression Taking	Art. No.	Name	Dimension	Material
	RB36510	Zeramex XT Transfer Open Tray RB	High sleeve: 11 mm / height incl. screw: 20 mm	Aluminium PEEK-CW30
	RB36512	Zeramex XT Transfer Closed Tray RB	High sleeve: 7 mm / height incl. screw: 14 mm	
	RB36513	Zeramex XT Transfer Closed Tray, long RB	High sleeve: 11 mm / height incl. screw: 18 mm	
	RB36522	Zeramex XT Implant Replica RB	Length: 10 mm	Aluminium

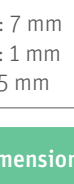

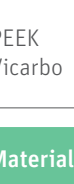
WB soft tissue management	Art. No.	Name	Dimension	Material
	WB37500	Zeramex XT Healing Cap WB	Height: 0.6 mm	PEEK
	WB37503	Zeramex XT Gingivaformer WB, 3 mm	Height: 3 mm Ø: 6 mm	
	WB37504	Zeramex XT Gingivaformer WB, 4 mm	Height: 4 mm Ø: 6 mm	
	WB37530	Zeramex XT Provisional WB (incl. screw)	AH: 7 mm CH: 1 mm Ø: 6 mm	PEEK Vicarbo







WB Impression Taking	Art. No.	Name	Dimension	Material
	WB37510	Zeramex XT Transfer Open Tray WB	High sleeve: 11 mm / height incl. screw: 20 mm	Aluminium PEEK-CW30
	WB37512	Zeramex XT Transfer Closed Tray WB	High sleeve: 7 mm / height incl. screw: 14 mm	
	WB37513	Zeramex XT Transfer Closed Tray, long WB	High sleeve: 11 mm / height incl. screw: 18 mm	

Range

XT





	WB37522	Zeramex XT Implant Replica WB	Length: 10 mm	Aluminium
---	---------	-------------------------------	---------------	-----------

SB/RB/WB Auxiliary Parts	Art. No.	Name	Dimension	Material
	RB36521	Zeramex XT Implant Replica Placer (SB/RB/WB)	Length: 14 mm	PEEK-CW30
	RB36550	Zeramex XT Provisional Screw (SB/RB/WB)	Length: 8.6 mm	Vicarbo
	RB36554	Zeramex XT Try-In Screw (SB/RB/WB)	Length: 7.1 mm	PEEK

Zeramex Docklocs®	Art. No.	Name	Material
	SB15542	Zeramex Docklocs® Abutment, 2 mm	ZrO ₂ -ATZ-HIP Vicarbo
	SB15543	Zeramex Docklocs® Abutment, 3 mm	
	SB15544	Zeramex Docklocs® Abutment, 4 mm	
	XT38227	Zeramex Docklocs® Insertion Instrument	Stainless steel PEEK
	XT38253	Docklocs® Laboratory Set, up to 40° divergence compensation: 2 pcs zirconium oxide retention housing (Ø5.8 mm, height 2.5 mm) with black processing insert (height 1.9 mm), 2 pcs block-out ring, 2 pcs replacement male, green, 2 pcs replacement male, orange, 2 pcs replacement male, red	Santroprene® TPE Polyamide Housing ZrO ₂ HD-PE Purell
	XT38251	Docklocs® Laboratory Set, up to 40° divergence compensation: 2 pcs titanium retention housing (Ø5.5 mm, height 2.5 mm) with black processing insert (height 1.9 mm), 2 pcs block-out ring, 2 pcs replacement male, green, 2 pcs replacement male, orange, 2 pcs replacement male, red	Santroprene® TPE Polyamide Titanium housing HD-PE Purell





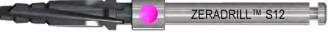





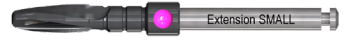
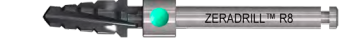
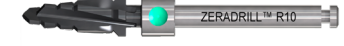

Range

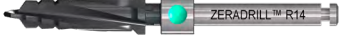
	XT38205	Docklocs® Replacement Male, red Extra-light retention, 10°-20° 8 pcs	Polyamide
	XT38206	Docklocs® Replacement Male, orange Light retention, 10°-20° 8 pcs	
	XT38207	Docklocs® Replacement Male, green Strong retention, 10°-20° 8 pcs	
	XT38209	Docklocs® Block-out Ring 20 pcs	Santroprene® TPE
	XT38230	Zirconium oxide retention housing with processing insert 2 pcs	Housing ZrO ₂ HD-PE Purell
	XT38210	Titanium retention housing with processing insert 4 pcs	Titanium housing G5 HD-PE Purell
	XT38214	Docklocs® lab analogue straight (Ø4 mm) 4 pcs	Grade 5 titanium
	XT38215	Docklocs® impression coping with black processing insert 4 pcs	Titanium housing G5 HD-PE Purell



SB/RB/WB Tools	Art. No.	Name	Material
	P35601	Zeramex Rosedrill Ø2 mm	Stainless steel
	T35602	Zeradriill Pilot Ø2.3 mm	
	XT35630	Zeramex Profile Drill SB	Stainless steel with carbon coating
	T35608	Zeradriill S8 (Small 8 mm)	
	T35610	Zeradriill S10 (Small 10 mm)	
	T35612	Zeradriill S12 (Small 12 mm)	

Range

XT

	T35614	Zeradrill S14 (Small 14 mm)	Stainless steel with carbon coating
	T35620	Zeratap Small Ø3.5 mm	
	T35622	Zeradrill Extension Small	
	T36608	Zeradrill R8 (Regular 8 mm)	
	T36610	Zeradrill R10 (Regular 10 mm)	
	T36612	Zeradrill R12 (Regular 12 mm)	
	T36614	Zeradrill R14 (Regular 14 mm)	
	T36620	Zeratap Regular Ø4.2 mm	
	T36622	Zeradrill Extension Regular	
	T37608	Zeradrill W8 (Wide 8 mm)	
	T37610	Zeradrill W10 (Wide 10 mm)	
	T37612	Zeradrill W12 (Wide 12 mm)	
	T37620	Zeratap Wide Ø5.5 mm	
	T37622	Zeradrill Extension Wide	
	C7650	Drill extension	

Range

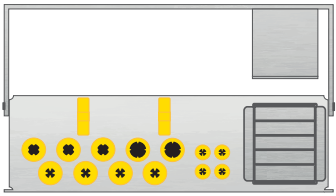
	T38650	Zeramex T depth gauge, 4 pcs	
	XT38619	Zeramex Prosthetic Key, 19 mm	
	XT38623	Zeramex Prosthetic Key, 23 mm	
	XT38628	Zeramex Prosthetic Key, 28 mm	
	XT36620	Zeramex Pick-up, 20 mm SB/RB/WB	Stainless steel
	XT36625	Zeramex Pick-up, 25 mm SB/RB/WB	
	XT36622	Zeramex Rescue Pick-up SB/RB/WB	
	P48932	Zeramex P Ratchet Adapter Unit Short	
	P48935	Zeramex P Surgical Ratchet without Adapter	
	XT35651	Zeramex XT Drill Stop, for Small Drill	PEEK
	XT36651	Zeramex XT Drill Stop, for Regular Drill	
	XT37651	Zeramex XT Drill Stop, for Wide Drill	
	XT48860	Zeramex XT Prosthetics Kit	
	XT48865	Zeramex XT Prosthetics Kit incl. Ratchet	

Range



	XT48850	Zeramex XT Surgery Tray	
	XT48854	Zeramex XT Surgery Tray, fully equipped, incl. Ratchet	

Docklocs® is a registered trademark of MEDEALIS GmbH and our alternative to the LOCATOR® technique.
 Santoprene® is a registered trademark of Exxon Mobil Corporation, USA.

	0050		Caution
	Article number		Expiry date
	Batch code		Observe the instructions for use
	Do not reuse		Date of manufacture
	Non-sterile		Manufacturer
	Sterilization by steam or dry heat		Do not use if the packaging is damaged
	Keep away from direct sunlight		The products of the portfolio are FDA-approved
	Keep dry		Medical device
	Unique Device Identifier		EU authorised representative
	Sterile barrier system		Double packaging with single internal sterile barrier
	Do not restilise		Gamma sterilization
Rx only	CAUTION: US federal law restricts the sale of this product to a physician or on his or her order.		
	Implant Small ø3.5 mm SB		Implant Regular ø4.2 mm RB
	Implant Wide ø5.5 mm WB		

General Information

Guarantee

Dentalpoint AG offers a lifelong guarantee for implants, and a 10-year guarantee for abutments and Vicarbo screws. Details of the guarantee can be found in the document “Zeramex Guarantee”.

Delivery and packaging

Delivery is in accordance with the general terms and conditions (T&Cs) of Dentalpoint AG. Intact double-sterile packaging protects the implant from external influences and ensures sterile storage up to the printed expiration date. Zeramex XT implants and components must be stored dry in their original packaging at room temperature and protected from sunlight. Only open the packaging shortly before surgery. We recommend comprehensive clinical, radiological and statistical documentation. The inside labels (patient label) must allow traceability of the implants.

Exclusion of liability

Zeramex XT implants are part of an overall system and may be used only with the components designed for this system. Dentalpoint AG will not be held liable for any damage

arising from improper use, or from using non-original components. The general terms and conditions of Dentalpoint AG also apply.

Training

For information on courses and further education for the Zeramex XT System, please contact us at www.zeramex.com.

Material properties

All implants and abutments are made from hot-densified zirconium oxide ATZ-HIP® (HIP = Hot Isostatic Postcompaction). For reasons of quality and strength, the implants and abutments are strictly machined into their final shape from solid, hard blanks using diamond-coated tools. The workpiece does not need finishing. This allows for highly precise and reproducible production of implants and abutments with the necessary precise fit.

Zerafil implant surface

- Microstructured
- Blasted and etched
- Hydrophilic

ZrO₂ ATZ-HIP

Zirconia dioxide, ATZ (alumina-toughened zirconia) (radiopaque)

Composition:

ZrO₂ 76%, Al₂O₃ 20%, Y₂O₃ 4%

Flexural strength: 1700 MPa

CTE: 9x10⁻⁶/K

ZrO₂ TZP-A

Zirconia dioxide, TZP (tetragonal zirconia polycrystal) (radiopaque)

Composition:

ZrO₂ 95%, Al₂O₃ 5%, Y₂O₃ 0.25%

Flexural strength: 1,200 MPa.

CTE: 10,5

PEEK CLASSIX

Polyether ether ketone USP Class VI (not radiopaque)

Aluminium

Aluminium (not radiopaque)

PEEK CLASSIX CW30 LSG

Short carbon fibres (CF) in a PEEK CLASSIX LSG matrix (not radiopaque)

Composition:

CF 30%, PEEK Classix LSG 70%

Flexural strength: >130 MPa

Vicarbo

Unidirectional carbon fibres (CF) in a PEEK matrix (not radiopaque)

Composition:

CF 60%, PEEK 40%

Flexural strength: >900 MPa.

Contact

USA

Distributor USA

Emerginnova LLC
2730 SW 3rd Avenue Suite 202-1
Miami, Florida 33129, USA
T 001 786 622 2016
sales@zeramexusa.com
www.emerginnova.com/zeramex

Global

You can find the contact
details of all sales
partners on our website
www.zeramex.com/contact.

